

FOSSIL CREEK RANCH

DESIGN GUIDELINES FOR ALL LOTS

UPDATED:

Table of Contents

- I. Introduction 5**
 - 1.1 Basis for Guidelines 5
 - 1.2 Contents of Guidelines 5
 - 1.3 Architectural Advisory Committee 5
 - 1.4 Committee Address and Phone..... 5
 - 1.5 Effect of Community and Supplemental Declarations 5
 - 1.6 Effect of Governmental and Other Regulations 5
 - 1.7 Interference with Utilities 6
 - 1.8 Goal of Guidelines 6
 - 1.9 Completion of Landscaping 6

- II. Specific Types of Improvements - Guidelines..... 6**
 - 2.1 General 6
 - 2.2 Accessory Buildings 6
 - 2.3 Additions and Expansions..... 6
 - 2.4 Address Numbers 7
 - 2.5 Advertising..... 7
 - 2.6 Air Conditioning Equipment 7
 - 2.7 Antennae 7
 - 2.8 Awnings 7
 - 2.9 Balconies..... 7
 - 2.10 BBQ/Gas Grills/Outdoor Kitchens/Smokers..... 7
 - 2.11 Basketball Backboards and Hoops 7
 - 2.12 Birdbaths 7
 - 2.13 Birdhouses and Bird Feeders..... 8
 - 2.14 Carports 8
 - 2.15 Clothes Lines and Hangers 8
 - 2.16 Cloth or Canvas Overhangs 8
 - 2.17 Compost 8
 - 2.18 Decks 8
 - 2.19 Doghouse..... 8
 - 2.20 Dog Runs..... 8
 - 2.21 Doors 9
 - 2.22 Drainage 9
 - 2.23 Driveways/Driveway Extensions 9
 - 2.24 Evaporative Coolers..... 9
 - 2.25 Exterior Lighting 9
 - 2.26 Fences..... 9
 - 2.27 Firewood Storage 9
 - 2.28 Flags/Flagpoles 9
 - 2.29 Garbage Containers and Storage Areas 10
 - 2.30 Gardens- Flower and Vegetable 10
 - 2.31 Gazebos 10
 - 2.32 Grading and Grade Changes..... 10

2.33 Greenhouses.....	10
2.34 Hanging of Clothes	10
2.35 Hot Tubs and Jacuzzis.....	10
2.36 Irrigation Systems.....	10
2.37 Jacuzzis	10
2.38 Kennels	10
2.39 Landscaping.....	10
2.40 Latticework.....	13
2.41 Lights and Lighting.....	13
2.42 Microwave Dishes	13
2.43 Overhangs/Awnings – Cloth or Canvas	13
2.44 Painting.....	13
2.45 Patio Covers.....	13
2.46 Patio (Enclosed).....	13
2.47 Patio (Open)	13
2.48 Paving	13
2.49 Pipes	14
2.50 Play Structures and Sports Equipment.....	14
2.51 Playhouses.....	14
2.52 Poles	14
2.53 Pools	14
2.54 Radio Antennae	14
2.55 Rooftop Equipment	14
2.56 Roofing Materials	14
2.57 Satellite Dishes	14
2.58 Saunas.....	14
2.59 Screen Doors	14
2.60 Seasonal Decorations and Holiday Lights.....	14
2.61 Sewage Disposal Systems.....	14
2.62 Sheds	15
2.63 Shutters, Exterior.....	15
2.64 Signs.....	15
2.65 Skylights.....	15
2.66 Solar Energy Devices	15
2.67 Spas.....	15
2.68 Sprinklers.....	15
2.69 Statues and Fountains	15
2.70 Storage Sheds.....	15
2.71 Sunshades.....	15
2.72 Swamp Coolers.....	15
2.73 Swing Sets.....	15
2.74 Television Antennae.....	16
2.75 Temporary Structures.....	16
2.76 Trash Containers, Enclosures and Pick up.....	16

2.77 Tree Houses.....	16
2.78 Utility Equipment	16
2.79 Vanes	16
2.80 Vents.....	16
2.81 Walls	16
2.82 Walls - Retaining.....	16
2.83 Weathervanes and Directionals	16
2.84 Wood Storage.....	16
2.85 Work Involving Common Areas.....	16
III. Procedures For Committee Approval	17
3.1 General	17
3.2 Drawing and/or Plans.....	17
3.3 Submittal Requirements.....	17
3.4 Review Fee.....	18
3.5 Action by Committee.....	18
3.6 Prosecution of Work.....	18
3.7 Rights of Appeal.....	18
3.8 Questions.....	18
IV. Landscaping Suggestions	18
4.1 General	18
4.2 Slopes	18
4.3 Submittal Requirements.....	18
4.4 Soil Preparation	19
4.5 Retaining Walls.....	19
4.6 Climate.....	19
4.7 Screening Views and Directing Winds	20
4.8 Rockscapes	20
4.9 Irrigation	20
4.10 Paved Areas.....	20
4.11 Shade	20
4.12 Landscape Materials.....	20
4.13 Mulches	21
4.14 Landscape Maintenance.....	21
4.15 Xeriscaping	21

I. INTRODUCTION

- 1.1 **Basis for Guidelines.** These Fossil Creek Ranch Design Guidelines for All Lots (the “Guidelines”) are intended to assist homeowners living in **Fossil Creek Ranch** in implementing landscaping and other home improvements to their property. The Declaration of Covenants, Conditions, and Restrictions for Fossil Creek Ranch (the “Declaration”) requires prior approval before the construction, installation, erection, or alteration of any structures, facilities, and appurtenances (each an “Improvement” as more fully defined in the Declaration) on any lot in **Fossil Creek Ranch**. For instance, any change to existing landscaping, new landscaping, or change to the final grade of property; the construction or installation of any accessory building, patio, deck, pool, or hot tub; the demolition or removal of any building or other improvement including changing paint colors must be submitted for prior approval. In order to assist homeowners, the Board of Directors of East Fossil Creek Ranch Metropolitan District No. 1 (the “District” intends to establish certain pre-approved designs for several types of Improvements and to exempt certain Improvements from the requirement for approval.
- 1.2 **Contents of Guidelines.** In addition to the introductory material, these Guidelines contain (A) a listing of specific types of Improvements that homeowners might wish to make with specific information as to each of these types of Improvements; (B) a summary of procedures for obtaining approval from the Architectural Review Committee; (C) Some helpful landscaping ideas and information.
- 1.3 **Architectural Review Committee.** The Architectural Review Committee (the “Committee”) consists of at least three (3) to no more than five (5) members, all of who are currently appointed by the Declarant and are to review requests for architectural approval.
- 1.4 **Committee Address and Phone.** The address of the Committee will be same as the address of the Management Company. This information can be found on the Design Request Form.
- 1.5 **Effect of Community and Supplemental Resolutions.** The Declaration is a document governing the community of Fossil Creek Ranch. Particular areas or groups of lots become part of Fossil Creek Ranch by annexation pursuant to a documents recorded subsequent to the Declaration. Copies of the Declaration, including amendments, are available at any time from the District. Each homeowner should review and become familiar with the Declaration, including amendments. Nothing in these Guidelines can supersede or alter the provisions or requirements of the Declaration and, if there is any conflict or inconsistency, the Declaration as amended will control.
- 1.6 **Effect of Governmental and Other Regulations.** Use of property and any Improvements must comply with applicable building codes and other governmental requirements and regulations. For general information about the Town of Windsor requirements, homeowners may call the Town of Windsor Community Development Department at (970) 674-2485 or visit the website <https://www.windsorgov.com/1247/Community-Development>

Approval by the Committee will not constitute assurance that Improvements comply with applicable governmental requirements or regulations or that a permit or approvals are not also required from applicable governmental bodies.

- 1.7 **Interference with Utilities.** In making Improvements to property, homeowners are responsible for locating all water, sewer, gas, electrical, cable television, or other utility lines or easements. Homeowners should not construct any Improvements over such easements without the consent of the utility involved and homeowners will be responsible for any damage to any utility lines. All underground utility lines and easements can be located by contacting: **Utility Notification Center of Colorado 1-800-922-1987 OR 811**
- 1.8 **Goal of Guidelines.** Compliance with these Guidelines and the provisions of the Declaration of Fossil Creek Ranch will help preserve the inherent architectural and aesthetic quality of Fossil Creek Ranch. It is important that Improvements to property be made in harmony with and not detrimental to the rest of the community. A spirit of cooperation with the Architectural Review Committee and neighbors will go far in creating an optimum environment, which will benefit all homeowners. By following these Guidelines and obtaining prior written approval for Improvements to property from the Committee, homeowners will be protecting their financial investment and will help ensure that Improvements to property are compatible with standards established. If a question ever arises as to the correct interpretation of any terms, phrases or language contained in these guidelines, the Architectural Review Committee interpretation thereof shall be final and binding.
- 1.9 **Completion of Landscaping.** If not installed by the builder, all landscaping on a lot must be completed within one-hundred and eight (180) days of the acquisition of the lot by the first owner; provided, however, if the acquisition occurs between April 1 and October 1, the owner shall be required to complete landscaping before the following October 1. **See Landscaping Section IV.**

II. SPECIFIC TYPES OF IMPROVEMENTS - GUIDELINES

- 2.1 **General.** The following is a listing, in alphabetical order, of a wide variety of specific types of improvements which homeowners typically consider installing, with pertinent information as to each. This is not an exhaustive, all-inclusive list. If in doubt, contact the District's manager or the Committee to confirm requirements or need to submit PRIOR to any exterior improvements, modifications, alterations or installations. **Unless otherwise specifically stated, drawings or plans for a proposed Improvement must be submitted to the Architectural Review Committee and written approval of the Committee obtained before the Improvements commence.** In some cases, where it is specifically so noted, a homeowner may proceed with the Improvements without advance approval if the homeowner follows the stated guideline. In some cases, where specifically stated, some types of Improvements are prohibited.
- 2.2 **Accessory Buildings. See Sheds Section 2.62.**
- 2.3 **Additions and Expansions.** Approval is required. Additions or expansions must be constructed of wood, Masonite, glass, brick, stone, or other material resembling the material used in construction of the exterior of the home. The design must be the same or generally recognized as a complimentary architectural style and meet all design guidelines as may be applicable. Colors must be the same as that of the residence.
- 2.4 **Address Numbers.** Approval is required to replace or relocate existing address numbers and shall be displayed in contrasting color and be visible from the street.
- 2.5 **Advertising.** All trade signs, which include, but are not limited to, landscaping, painting, and roofing, may only be displayed while work is in progress and must be removed upon completion of the job. **See Signs. Section 2.65.**
- 2.6 **Air Conditioning Equipment/HVAC.** Approval is required for all air conditioning equipment including evaporative coolers (swamp coolers) and attic ventilators. No heating, air conditioning, air movement (e.g. swamp coolers) or refrigeration equipment shall be placed or installed on rooftops or extended from windows.
- 2.7 **Antennae.**

"Permitted Antennas" are defined as (a) an antenna which is one meter or less in diameter and is designed to receive direct broadcast satellite service, including direct-to-home satellite service, or to receive or transmit fixed wireless signals via satellite; (b) an antenna which is one meter or less in diameter or diagonal measurement and is designed to receive video programming services via broadband radio service (wireless cable) or to receive or transmit fixed wireless signals other than via satellite; (c) an antenna which is designed to receive local television broadcast signals; or (d) other antennas which are expressly permitted under applicable federal statutes or regulations. In the event a Permitted Antenna is no longer expressly permitted under applicable federal statutes or regulations, such antenna will no longer be a Permitted Antenna for purposes of this Section. Installation of Permitted Antennas shall not require the approval of the ARC.

All Permitted Antennas shall be installed with emphasis on being as unobtrusive as possible to the Community. To the extent that reception is not substantially degraded or costs unreasonably increased, all Permitted Antennas shall be screened from view from any street and nearby lots to the maximum extent possible, and placement shall be made in the following order of preference:

- (1) Inside the structure of the house, not visible from the street
- (2) Rear yard or side yard, behind and below the fence line
- (3) Rear yard or side yard, mounted on the house, in the least visible location below roofline
- (4) Side yard in front of wing fence, screened by and integrated into landscaping
- (5) Back rooftop
- (6) Front yard screened by and integrated into landscaping.

If more than one location on the lot allows for adequate reception without imposing unreasonable expense or delay, the order of preference described above shall be used, and the least visible site shall be selected.

Permitted Antennas shall not encroach upon common areas or any other owners' property.

All cabling must be run internally when feasible, must be securely attached, and must be as inconspicuous as possible. Any external wiring shall be run under eaves, along siding or next to downspouts to be as inconspicuous as possible. Permitted Antennas, masts and any visible wiring may be required to be painted to match the color of the structure to which they are attached. The owner should check with the installer/vendor for the appropriate type of paint.

All other antennas, not addressed above, are prohibited.

2.8 **Awnings. See Overhangs/Awnings Cloth or Canvas Section 2.43.**

2.9 **Balconies. See Decks Section 2.18.**

2.10 **Barbecue/Gas Grills/Outdoor Kitchens/Smokers.** All barbecue grills, smokers, etc. must be maintained in the rear yard or within an enclosed structure, not visible from the front of the home.

2.11 **Basketball Backboards.** No basketball backboards shall be attached to the garage. Only portable basketball backboards shall be allowed and do not require approval if the following guidelines are met: 1) portable units cannot be placed in the public rights of way, streets, or sidewalks; 2) location must be at least half of the length of the driveway away from the street. Portable basketball backboards shall be stored out of sight when not in use.

2.12 **Birdbaths, Fountains and Yard Art.** Approval is not required for one birdbath, fountain or piece of yard art if placed in the rear yard and if finished height is no greater than five (5) feet including any pedestal. Placement in front or side yard is not allowed.

- 2.13 **Birdhouses and Bird Feeders.** Approval is not required for birdhouse or bird feeder if installed in the rear yard and the size is limited to one foot by two feet. No more than three in number, of each, shall be installed on any lot. If a birdhouse or bird feeder is mounted on a pole, the pole may not exceed six (6) feet in height.
- 2.14 **Carports.** Are not permitted.
- 2.15 **Clothes Lines and Hangers.** Approval is not required if placed in the backyard and not visible from a street or from the ground level of any adjacent lot. All clotheslines must be retractable and retracted when not actively in use.
- 2.16 **Cloth or Canvas Overhangs. See Overhangs/Awnings Cloth or Canvas Section 2.43.**
- 2.17 **Compost.** Approval is required. Container must not be visible from the street or the ground level of any adjacent lot, and odor must be controlled. Underground composting is not allowed.
- 2.18 **Decks.** Approval is required. The deck must be constructed of redwood or composite type decking products approved by the **ARC**. The decking material must be either redwood in color or of a color that matches one of the exterior paint colors or the masonry on the home. Maintenance free (composite) decking products may be used if the decking material is either redwood in color or of a color that matches one of the exterior paint colors or masonry on the home. The deck should be located so as not to create an unreasonable level of noise for adjacent property owners.
- Homeowners are reminded that as with redwood, some types of maintenance free decking products may also require periodic maintenance for proper care and to retain the products aesthetic conformity, including but not limited to, fading, warping, etc. Decks may be finished with clear semi-transparent sealer, stained to match a redwood tone; an oil-based wood finish or a similar product that matches. The deck may also be painted to match the body or trim color of the home.
- 2.19 **Dog Houses.** Approval is required. Doghouses are restricted to ten (10) square feet and must be located in a fenced back yard or dog run. Doghouses must be installed at ground level and must not be visible above the fence. Must match exterior of home (wood, brick, stone, etc.) Limit of one doghouse per home/lot. **See Fences, Section 2.26 and Exhibit B.**
- 2.20 **Dog Runs.** Committee approval is required. Dog runs must be located in the rear or side yard, abutting the home and substantially screened from view by planting fast- growing or mature trees or shrubs. Dog runs will be limited to 200 square feet and cannot be higher than 4 feet 6 inches. **The fencing materials and design shall match Exhibit B.** The dog run fence should be left natural in color and sealed to prevent weathering. Tarpaulins and chain-link will not be permitted.
- 2.21 **Doors.** Approval is not required for an already existing main entrance door to a home or an accessory building if the material matches the door to be replaced and if the color is generally accepted as a complimentary color to that of existing doors on the house. Complementary

colors would be the body color of the house.

- A. Storm Doors. Approval is required for storm doors. Colors should be complimentary with the color scheme of the home.
- B. Security Doors and Windows. All security or security-type doors and windows must be approved prior to installation. No bar style security doors will be permitted.

2.22 **Drainage.** The Declaration requires that there be no interference with the established drainage pattern over any property. The established drainage pattern means the drainage pattern as engineered and constructed by the homebuilder prior (or in some cases, immediately following) conveyance of title from the home builder to the first homeowner. When installing your landscaping, it is very important to ensure that water drains away from the foundation of the house and that the flow patterns prevent water from flowing under or against the house foundation, walkways, sidewalks, and driveways into the street. The Committee may require a report from a drainage engineer as part of landscaping or Improvement plan approval. Landscaping should conform to the established drainage pattern. Sump pump drainage should be vented a reasonable distance from the property line, on the owner's property, to allow for absorption. Adverse effects to adjacent properties will not be tolerated.

2.23 **Driveways/Driveway Extensions.** Parking in rear or side yard is not permitted. Approval is required for driveway extensions.

2.24 **Evaporative Coolers.** Approval is required. No rooftop or window mount installations are allowed. **See Air Conditioning Equipment Section 2.06.**

2.25 **Exterior Lighting.** See **Lights and Lighting Section 2.41.**

2.26 **Fences.** Approval is required. Both fencing types listed below are permitted. Please reference the attached fencing plan to note which type of fencing is permitted dependent on location in the neighborhood.

- A. Split Rail Fence: Fence shall not exceed 44 inches in height to the top of the top rail. All materials shall consist of 4x6 cedar posts and 2x6 cedar rails. Fence shall be stained with Olympic stain #730 Teak.

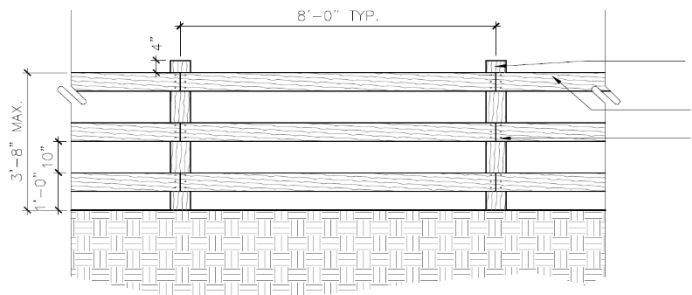

- NOTES:
- 1. FENCE SHALL NOT EXCEED 44 INCHES IN HEIGHT TO THE TOP OF THE TOP RAIL.
 - 2. ALL MATERIALS SHALL CONSIST OF 4x6 CEDAR POSTS AND 2x6 CEDAR RAILS.
 - 3. FENCE SHALL BE STAINED WITH OLYMPIC STAIN #730 TEAK.

B SPLIT RAIL FENCE

SCALE: 1/2" = 1'-0"

01-FENCE-INDY

FILING 1

FILING 1

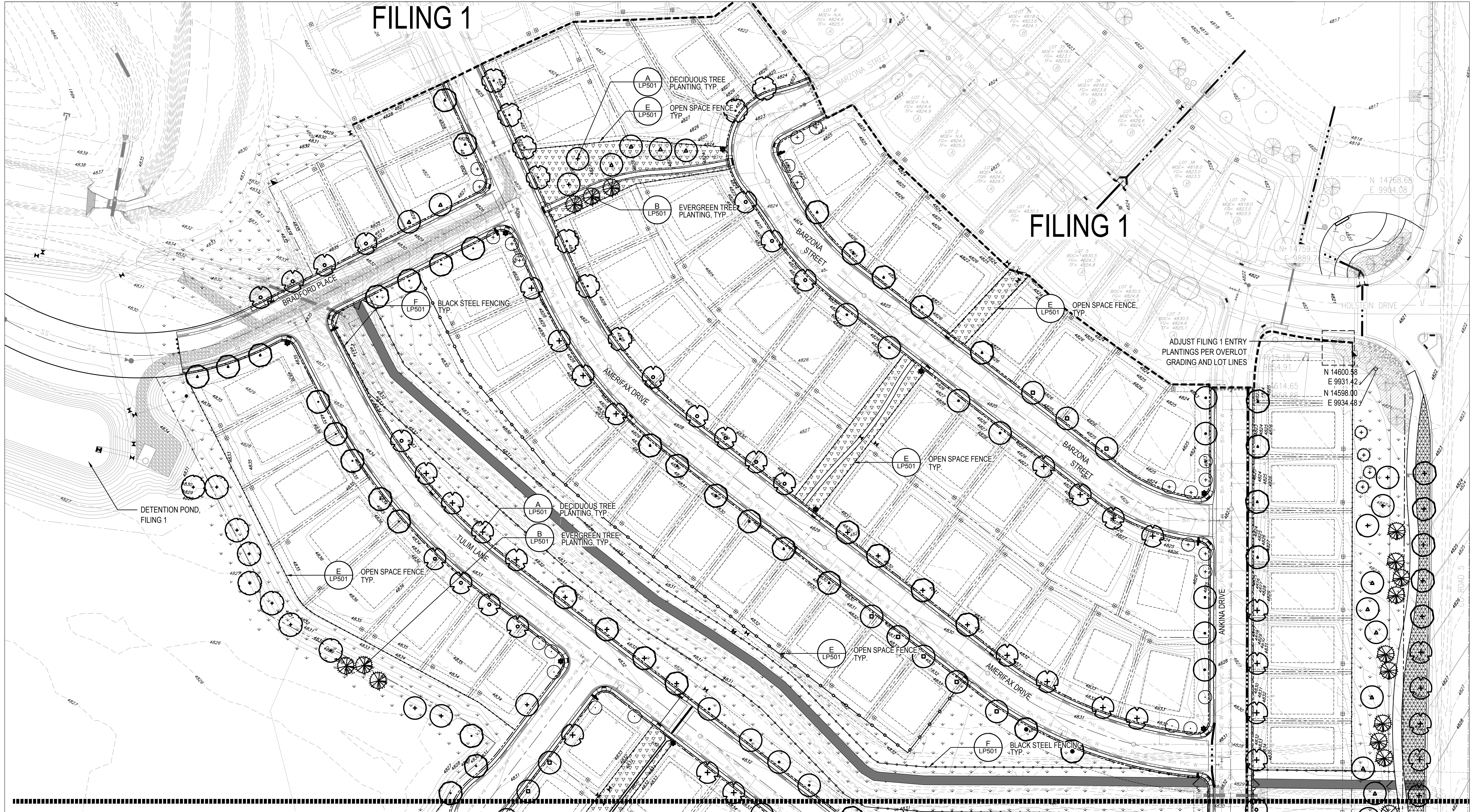

REV.	COMMENT	DATE
1	FENCING UPDATE	5/24/23
2	LANDSCAPE NOTES UPDATE	5/3/23
3	LANDSCAPE NOTES, FENCE UPDATE	6/15/23

LANDSCAPE LEGEND:

	80/20 FESCUE/BUEGRASS MIX SOD (INCLUDES SOD BETWEEN ROW AND BACK OF WALK) - 11,548 SF
	80/20 FESCUE/BUEGRASS SEEDED TURF - 42,451 SF
	NATIVE SEED MIX - 242,942 SF 23% - BLUE GRAMA 10% - BUFFALO GRASS 20% - GREEN NEEDLEGRASS 20% - SIDE OATS GRAMA 10% - WESTERN WHEATGRASS 2% - SAND DROPSSEED 10% - INDIAN RICEGRASS 5% - NEEDLE AND THREADGRASS
	SHRUB PLANTING - 1,049 SF
	OPEN SPACE FENCE - SEE DETAILS
	BLACK STEEL FENCE - SEE DETAILS
	DETENTION SEED MIX - 64,531 SF 15% - AMERICAN SLOUGHGRASS 10% - NEBRASKA SEDGE 05% - CREEPING SPIKERUSH 10% - HARDSTEM BULLRUSH 10% - ALKALI BULLRUSH 10% - SWITCHGRASS 15% - WESTERN WHEATGRASS 10% - PRAIRIE CORDGRASS 15% - CANADA WILDRYE

LANDSCAPE SCHEDULE

QTY	SYMBOL	%	ID	BOTANIC NAME	COMMON NAME	SIZE
DECIDUOUS TREES						
13		3.3%	CSP	CATALPA SPECIOSA	NORTHERN CATALPA	2" CAL.
32		8.0%	COC	CELTIS OCCIDENTALIS	HACKBERRY	2" CAL.
20		5.5%	GTR	GLEDITSIA TRIACANTHOS INERMIS 'SHADEMASTER'	SHADEMASTER HONEYLOCUST	2" CAL.
19		4.8%	GIN	GLEDITSIA TRIACANTHOS INERMIS 'SKYCOLE'	SKYLINE HONEYLOCUST	2" CAL.
39		9.8%	GDI	GYMNOCLADUS DIOICA 'EXPRESSO'	EXPRESSO KENTUCKY COFFEETREE	2" CAL.
20		5.0%	UAC	ULMUS 'ACCOLADE'	ACCOLADE ELM	2" CAL.
PLAINS COTTONWOOD						
8.0%	PSA	POPULUS SARGENTII (NOT USED AS STREET TREE)	PLAINS COTTONWOOD	2" CAL.		
TEXAS RED OAK						
6.0%	QBU	QUERCUS BUCKLEYI	TEXAS RED OAK	2" CAL.		
BUR OAK						
3.8%	QMA	QUERCUS MACROCARPA (BULLET GALL RESISTANT)	BUR OAK	2" CAL.		
CHINKAPIN OAK						
7.0%	QME	QUERCUS MEUHLBERGII	CHINKAPIN OAK	2" CAL.		
AMERICAN SENTRY LINDEN						
5.0%	TAM	TILIA AMERICANA 'SENTRY'	AMERICAN SENTRY LINDEN	2" CAL.		
GREENSPIRE LINDEN						
4.8%	TCO	TILIA CORDATA 'GREENSPIRE'	GREENSPIRE LINDEN	2" CAL.		
ACCOLADE ELM						
5.0%	UAC	ULMUS 'ACCOLADE'	ACCOLADE ELM	2" CAL.		

QTY	SYMBOL	%	ID	BOTANIC NAME	COMMON NAME	SIZE
SHRUBS						
6		4.8%	MSP	MALUS 'SPRING SNOW'	SPRING SNOW CRABAPPLE	1.5"
6		4.8%	CLA	CARYOPTERIS X CLANDONENSIS	BLUE MIST SPIREA	5 GAL.
7		2.0%	MTH	MALUS 'THUNDERCHILD'	THUNDERCHILD CRABAPPLE	1.5" CAL.
ORNAMENTAL GRASSES (SYMBOL ENLARGED FOR CLARITY)						
12		4.5%	PCA	PYRUS CALLERYANA	CHANTICLEER PEAR	1.5" CAL.
8		3.3%	JSO	JUNIPERUS SCOPULORUM	ROCKY MTN. JUNIPER	6' H
20		1.8%	JSC	JUNIPERUS SCOPULORUM 'COLOGREEN'	COLOGREEN JUNIPER	6' HT.
53		13.3%	PNI	PINUS NIGRA	AUSTRIAN PINE	6' HT.

LAND USE TABLE:

OPEN SPACE:	362,521 S.F. - 6.2%
PUBLIC STREET:	230,540 S.F. - 4.3%
SIDEWALK & PATHWAYS:	77,181 S.F. - 1.4%

A FINAL LANDSCAPE ENLARGEMENT PLAN

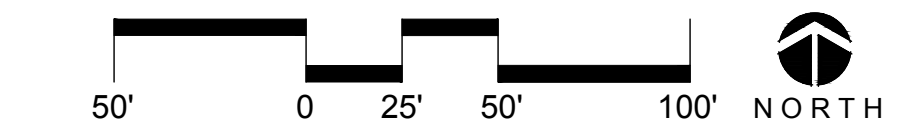

russell+mills

FOSSIL CREEK RANCH
FILING 2
Final Landscape Enlargement Plan

Date: SEPT 2020
Drawn By: MT
Checked By: JB

REV.	COMMENT	DATE
1	FENCING UPDATE	5/24/23
2	LANDSCAPE NOTES UPDATE	5/3/23
3	LANDSCAPE NOTES: FENCE UPDATE	6/15/23

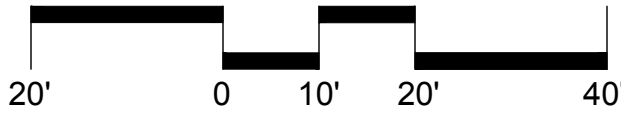
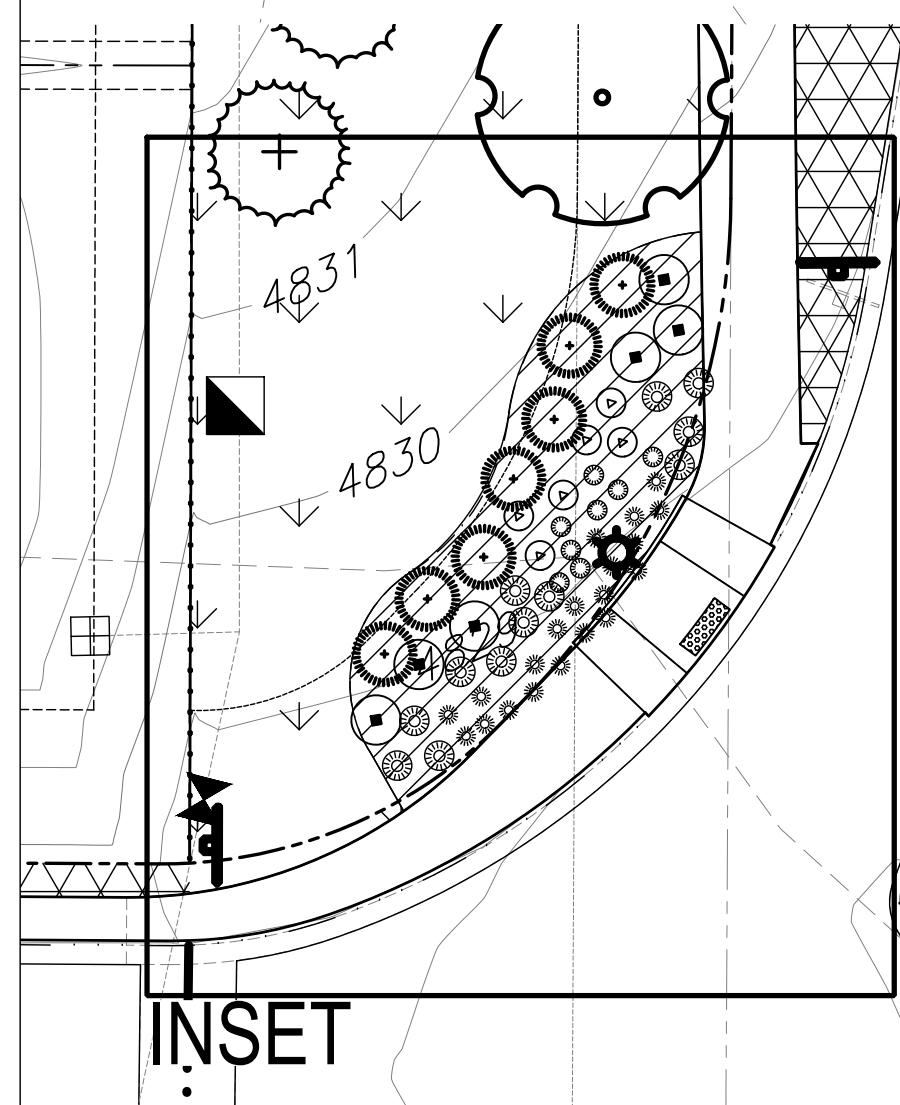
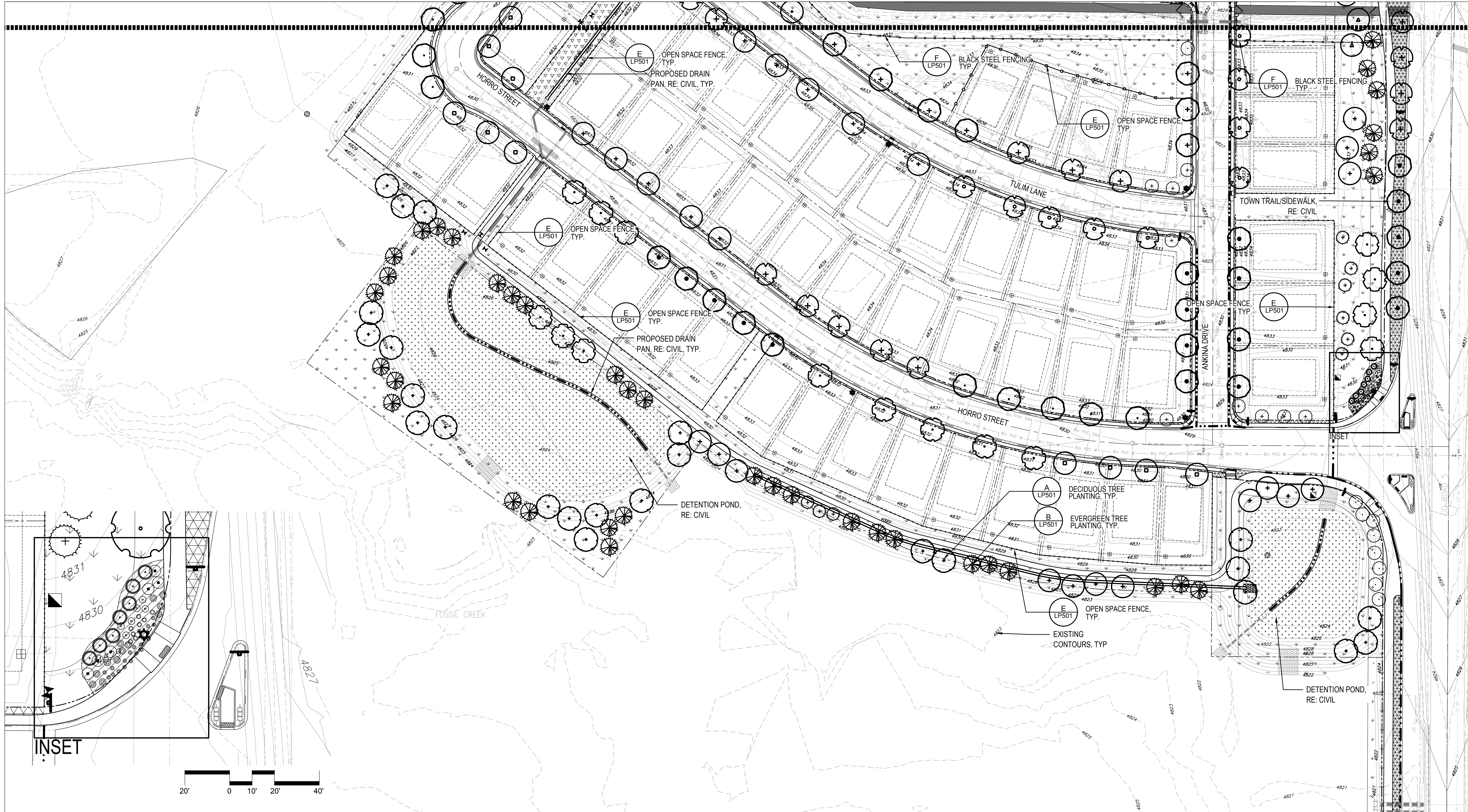

LANDSCAPE LEGEND:

80/20 FESCUE/BUEGRASS MIX SOD (INCLUDES SOD BETWEEN ROW AND BACK OF WALK) - 11,548 SF	SHRUB PLANTING - 1,049 SF
80/20 FESCUE/BUEGRASS SEEDED TURF - 42,451 SF	OPEN SPACE FENCE - SEE DETAILS BLACK STEEL FENCE - SEE DETAILS
NATIVE SEED MIX - 242,942 SF. 23% - BLUE GRAMA 10% - BUFFALO GRASS 20% - GREEN NEEDLEGRASS 20% - SIDE OATS GRAMA 10% - WESTERN WHEATGRASS 2% - SAND DROPSSEED 10% - INDIAN RICEGRASS 5% - NEEDLE AND THREADGRASS	DETENTION SEED MIX - 64,531 SF. 15% - AMERICAN SLOUGHGRASS 10% - NEBRASKA SEDGE 20% - CREEPING SPIKERUSH 10% - HARDSTEM BULLRUSH 10% - ALKALI BULLRUSH 15% - SWITCHGRASS 10% - WESTERN WHEATGRASS 10% - PRAIRIE PONDGRASS

LAND USE TABLE:
 OPEN SPACE: 362,521 S.F. - 6.2%
 PUBLIC STREET: 230,540 S.F. - 4.3%
 SIDEWALK & PATHWAYS: 77,181 S.F. - 1.4%

DECIDUOUS TREES		QTY	SYMBOL	%	ID	BOTANIC NAME	COMMON NAME	SIZE	32
13		3.3%	CSP	CATALPA SPECIOSA	NORTHERN CATALPA	2" CAL.	24		6.0%
32		8.0%	COC	CELTIS OCCIDENTALIS	HACKBERRY	2" CAL.	13		3.8%
20		5.5%	GTR	GLEDITSIA TRIACANTHOS INERMIS 'SHADEMASTER'	SHADEMASTER HONEYLOCUST	2" CAL.	26		7.0%
19		4.8%	GIN	GLEDITSIA TRIACANTHOS INERMIS 'SKYCOLE'	SKYLINE HONEYLOCUST	2" CAL.	20		5.0%
39		9.8%	GDI	GYNOCLADUS DIOICA 'EXPRESSO'	EXPRESSO KENTUCKY COFFEETREE	2" CAL.	19		4.8%
			UAC	ULMUS 'ACCOLADE'	ACCOLADE ELM	2" CAL.	20		13.3%

ORNAMENTAL TREES		QTY	SYMBOL	%	ID	BOTANIC NAME	COMMON NAME	SIZE	
17		4.8%	MSP	MALUS 'SPRING SNOW'	SPRING SNOW CRABAPPLE	1.5"	6		6
7		2.0%	MTH	MALUS 'THUNDERCHILD'	THUNDERCHILD CRABAPPLE	1.5" CAL.	7		6
18		4.5%	PCA	PYRUS CALLERYANA	CHANTICLEER PEAR	1.5" CAL.	18		12
13		3.3%	JSO	JUNIPERUS SCOPULORUM	ROCKY MTN. JUNIPER	6' H	13		8
7		1.8%	JSC	JUNIPERUS SCOPULORUM 'COLOGREEN'	COLOGREEN JUNIPER	6' HT.	7		20
53		13.3%	PNI	PINUS NIGRA	AUSTRIAN PINE	6' HT.	53		

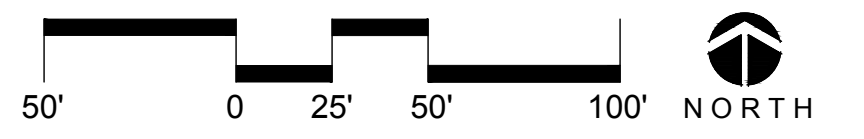

A FINAL LANDSCAPE ENLARGEMENT PLAN

russell+mills

FOSSIL CREEK RANCH
 FILING 2
 Final Landscape Enlargement Plan

Date: SEPT 2020
 Drawn By: MT
 Checked By: JB

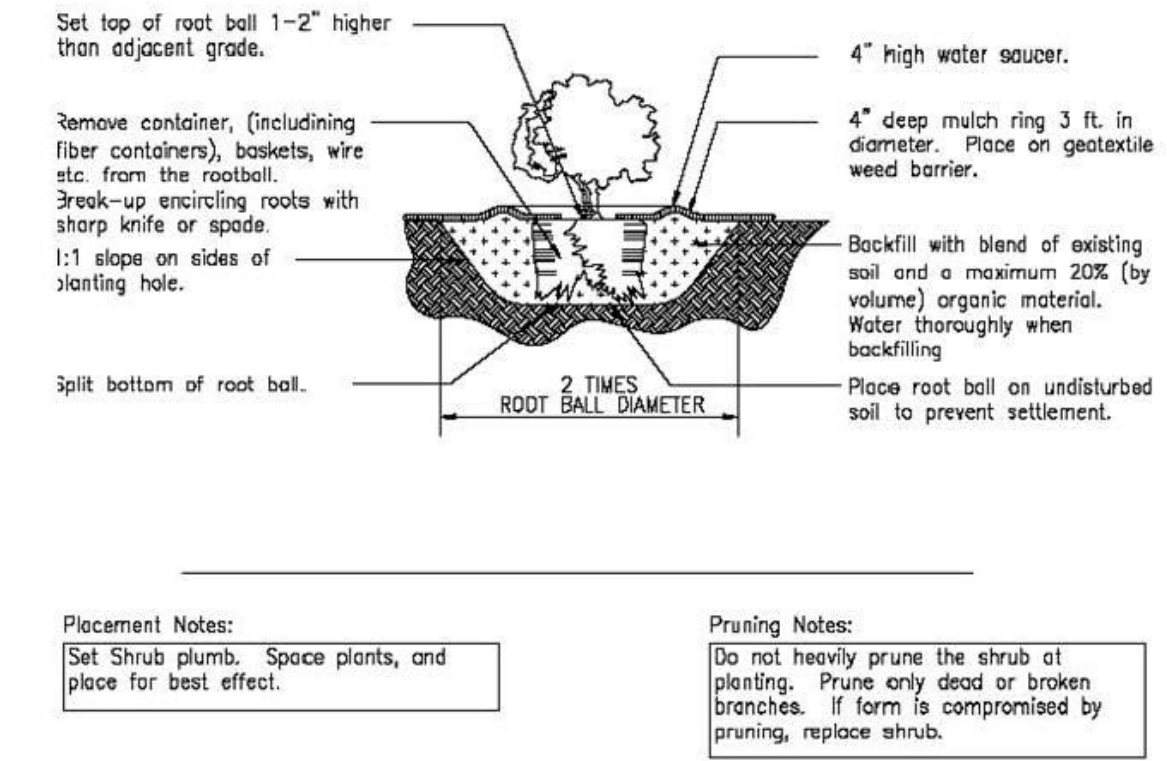
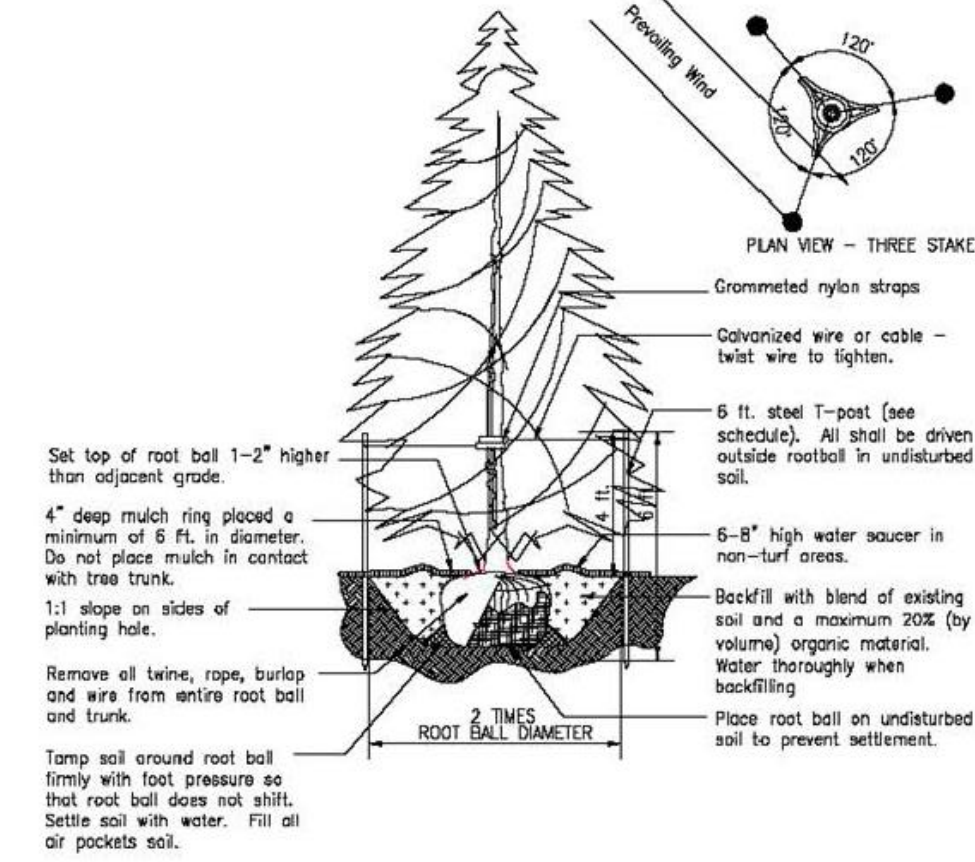
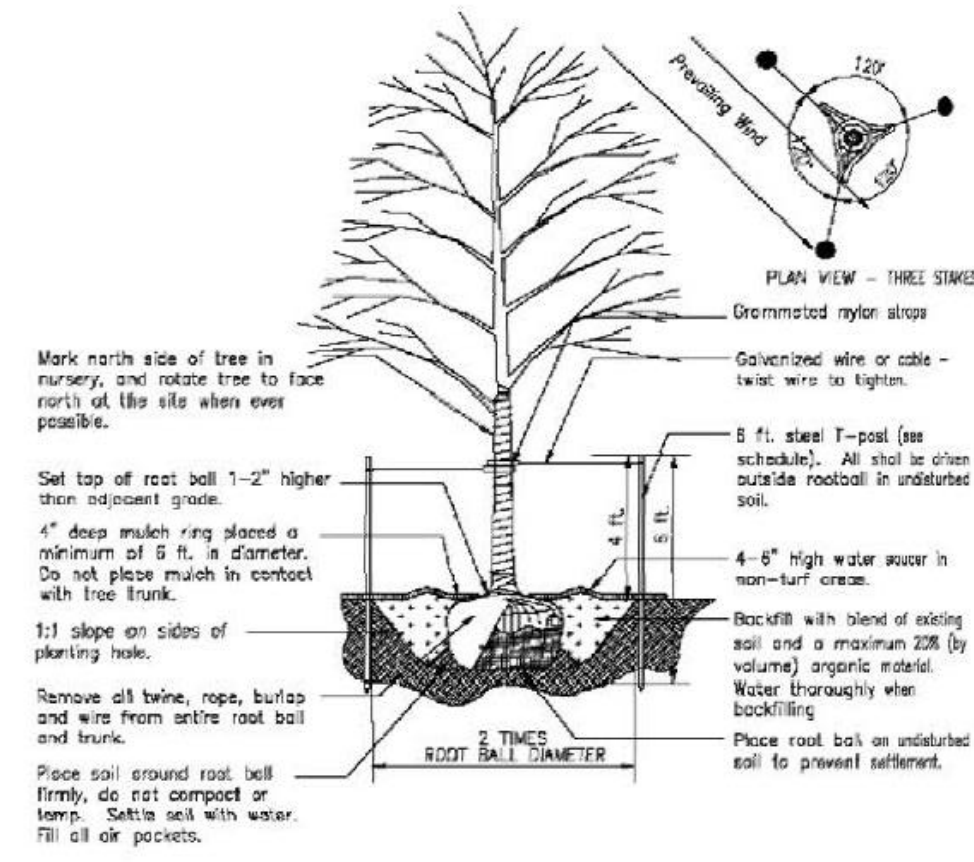

A DECIDUOUS TREE PLANTING
SCALE: NTS

B EVERGREEN TREE PLANTING
SCALE: NTS

C SHRUB PLANTING
SCALE: NTS

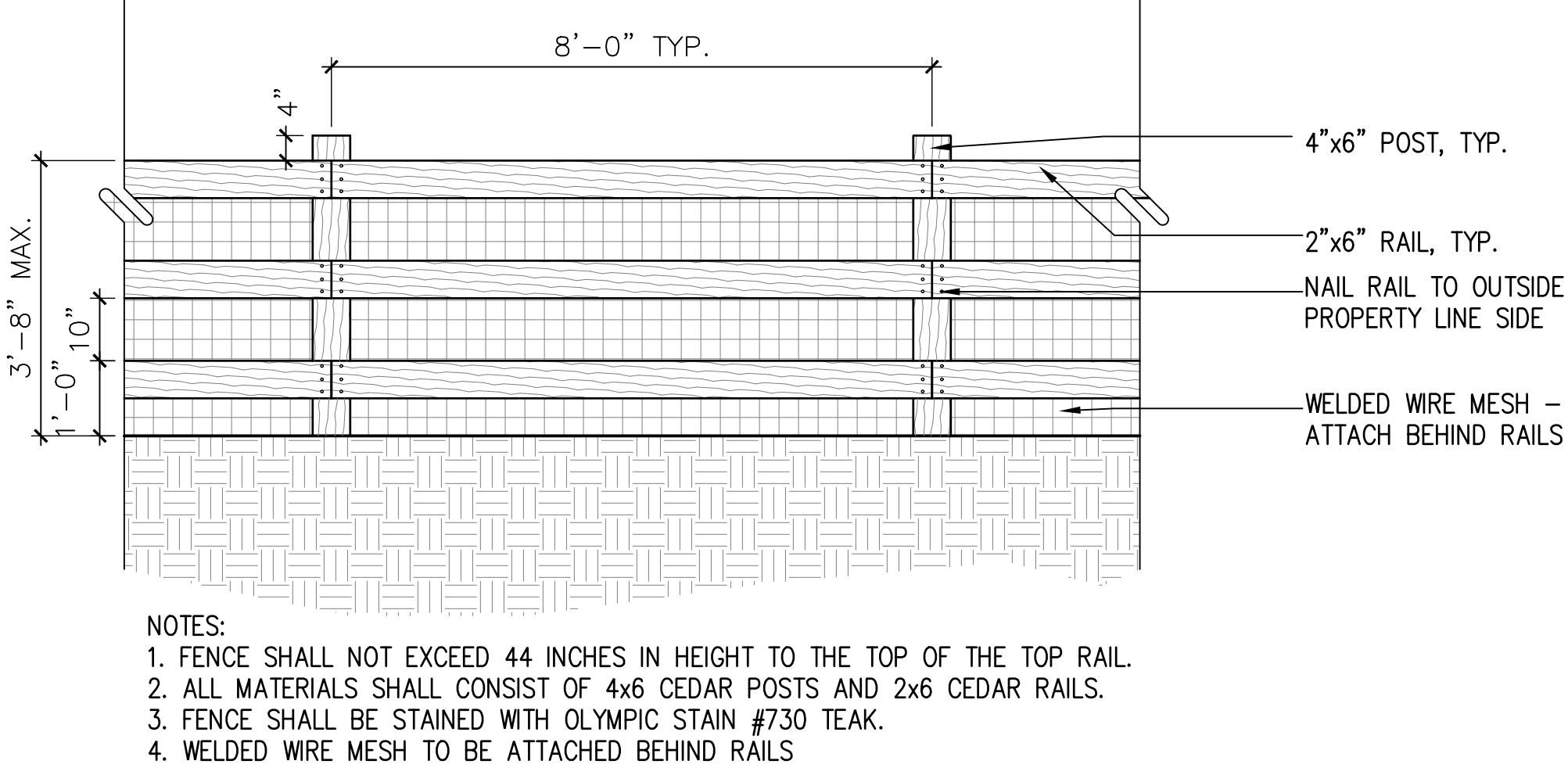
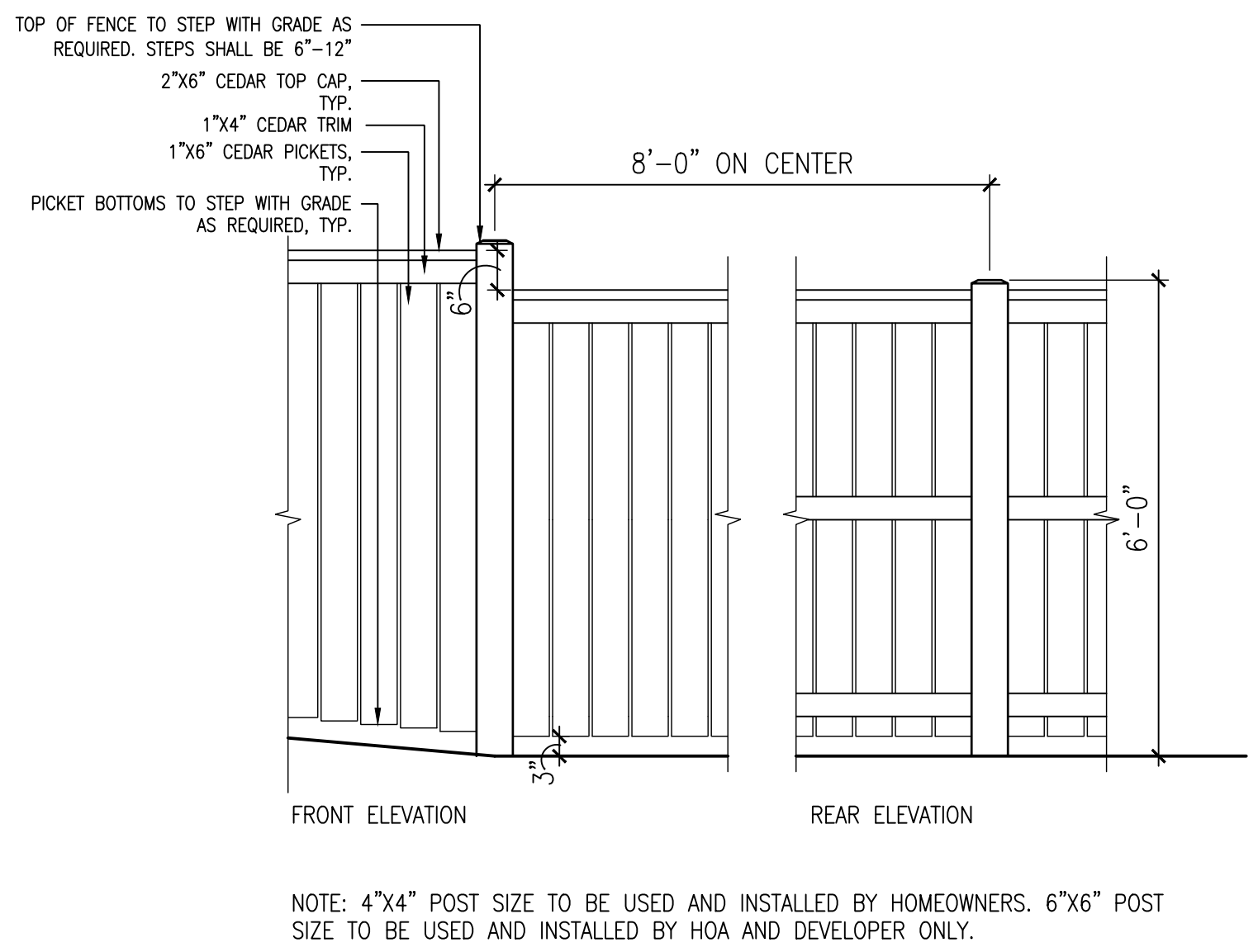

D 6' PRIVACY FENCE
SCALE: 1/2"=1'-0"

E OPEN SPACE FENCE
SCALE: 1/2"=1'-0" DT-FENCE-BNDY

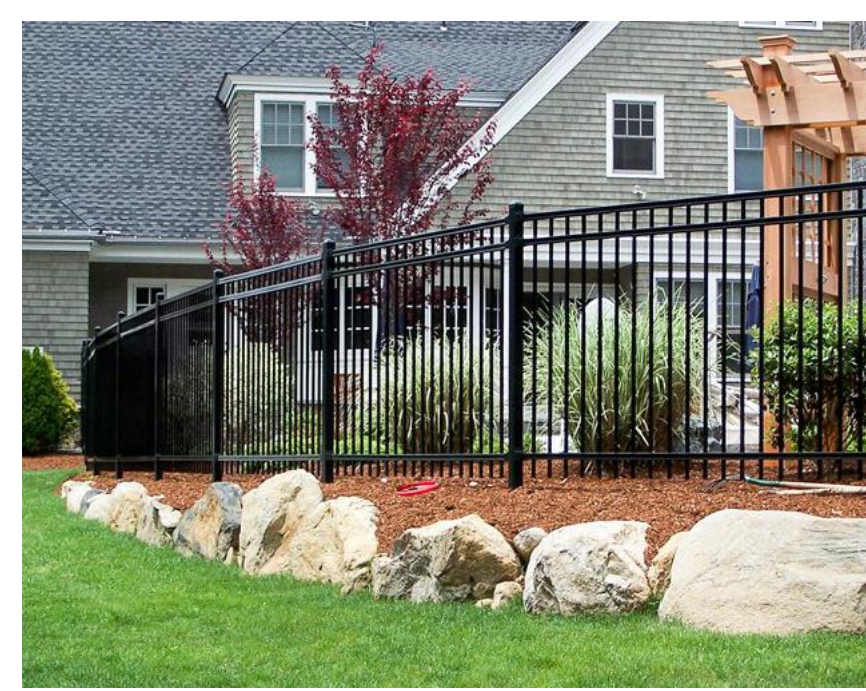

COMPANY: AMERISTAR FENCING
MODEL: MONTAGE
STYLE: MAJESTIC, WITH FLUSH BOTTOM RAIL, MATCHING GATE
COLOR: BLACK
HEIGHT: 6 FT.
CONTACT: 1-888-333-3422
(WWW.AMERISTARFENCE.COM)
INSTALL PER MANUFACTURER RECOMMENDATIONS AND SPECIFICATIONS.

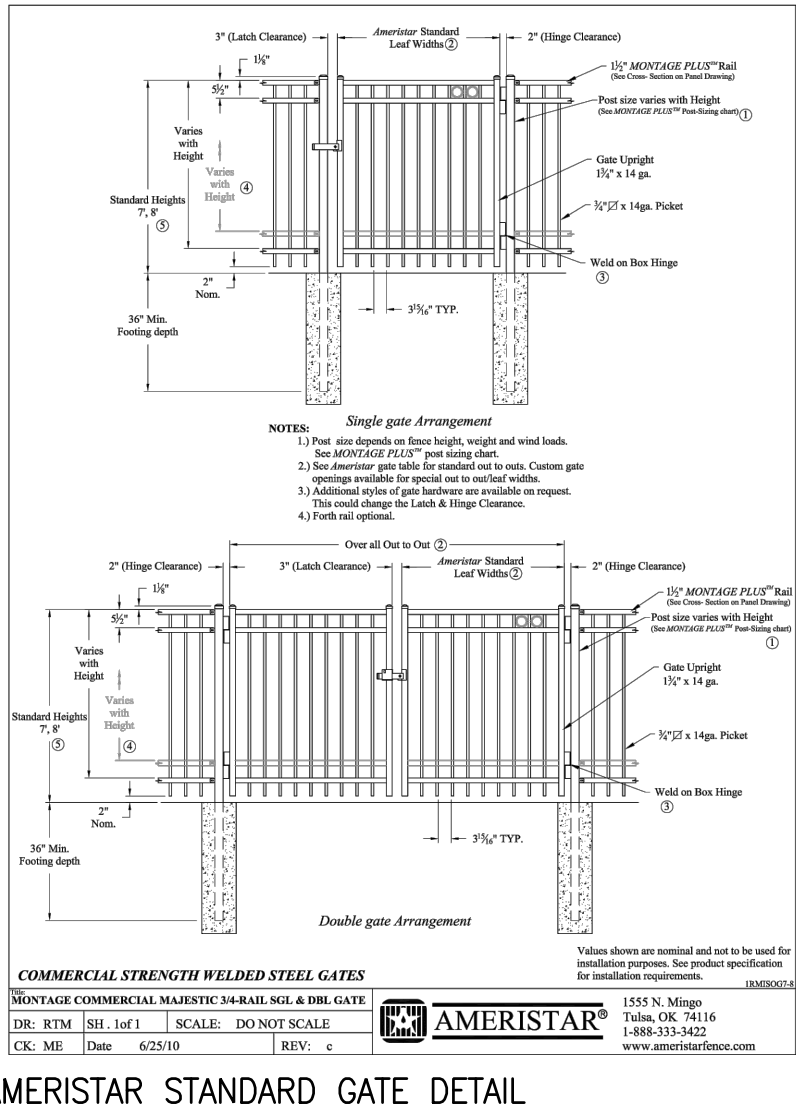
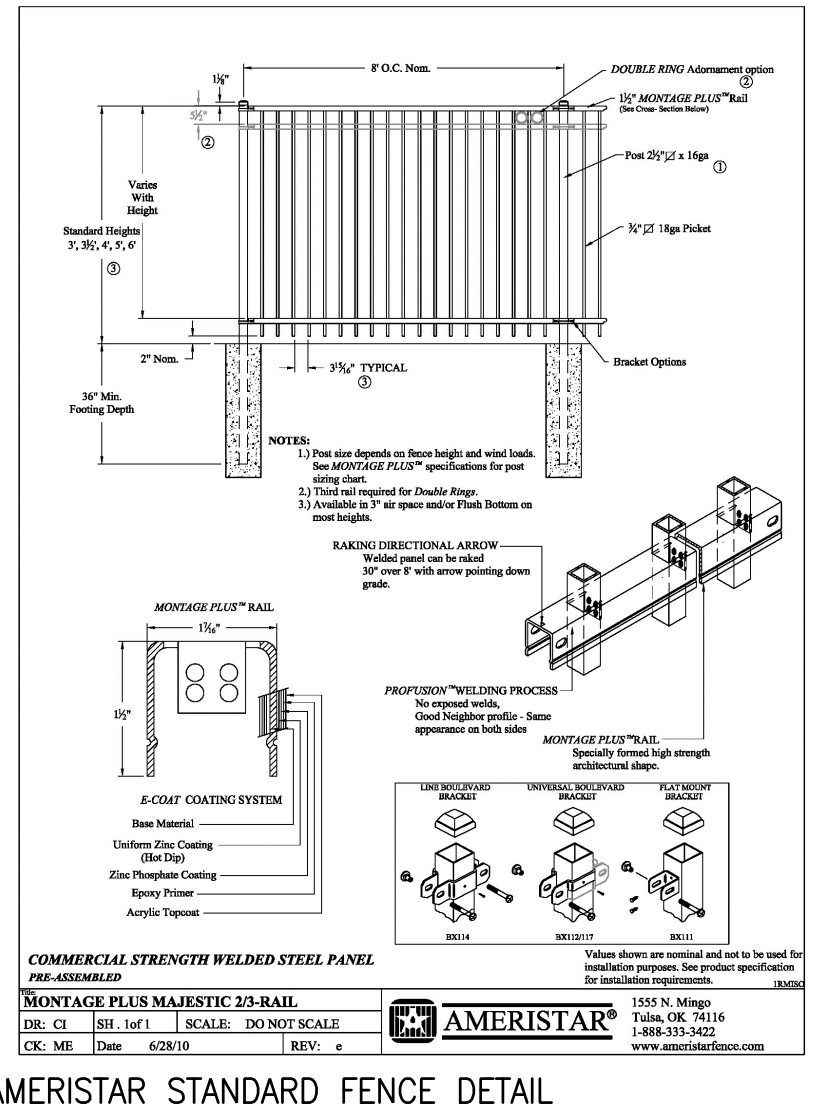

F BLACK STEEL FENCING
SCALE: NTS

NOTES: GATES TO HAVE ALLEGION SCHLAGE HANDKEY II BIOMETRIC LOCK WITH FX ENCLOSURE. LOCKS TO BE INSTALLED PER MANUFACTURER'S SPECIFICATIONS. CONTRACTOR TO CONFIRM INSTALLATION INSTRUCTIONS WITH ALLEGION PRIOR TO GATE FABRICATION TO ENSURE LOCK IS INSTALLED PROPERLY.

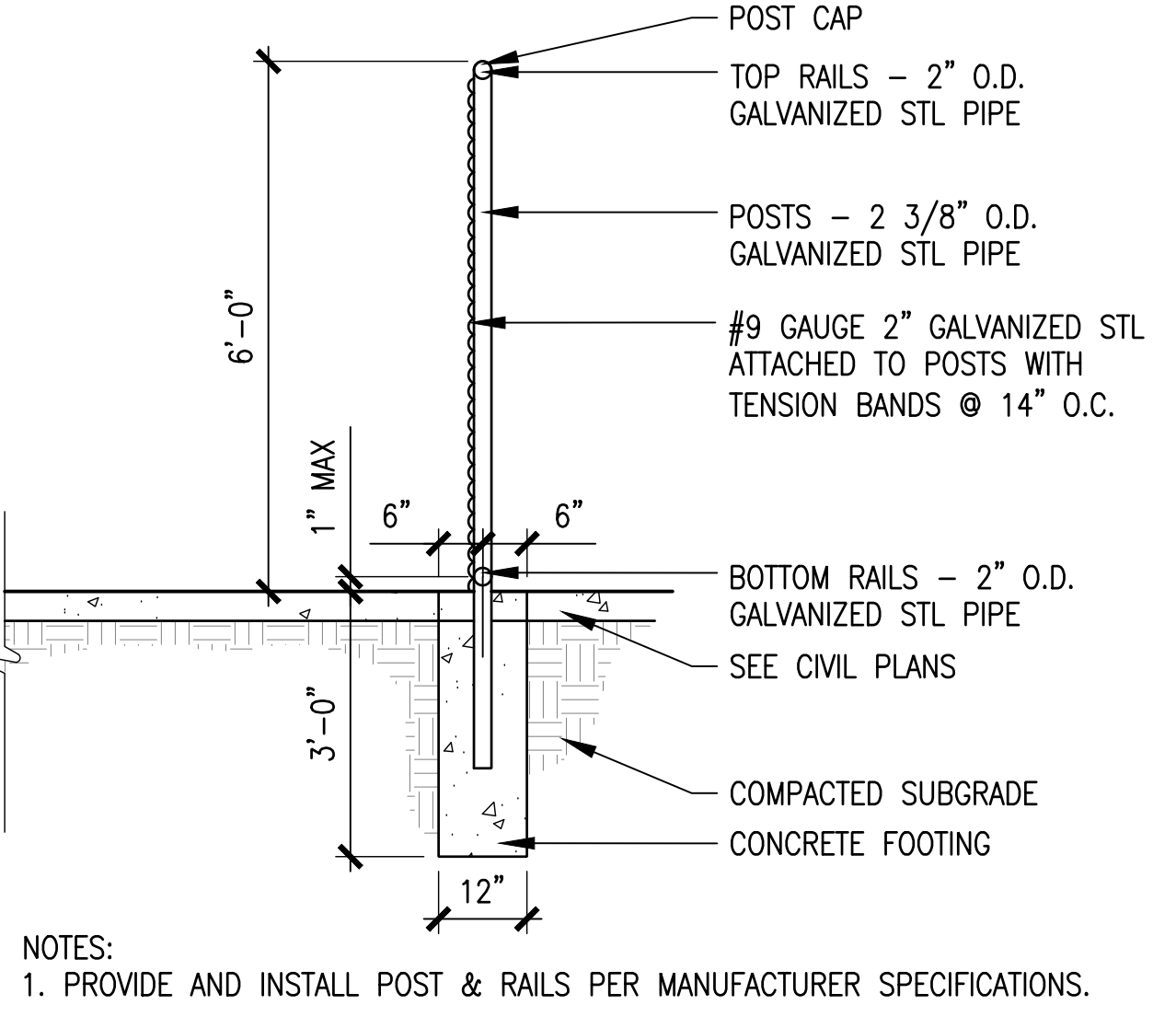

G 6' CHAINLINK FENCE
SCALE: 1/2"=1'-0" DT-FENC-CHAN-LINK-6

REV.	COMMENT	DATE
1	FENCING UPDATE	5/24/23
2	LANDSCAPE NOTES UPDATE	5/3/23
3	LANDSCAPE NOTES, FENCE UPDATE	6/15/23

russell+mills

FOSSIL CREEK RANCH
FILING 2
Final Landscape Details

Date: SEPT 2020
Drawn By: MT
Checked By: JB

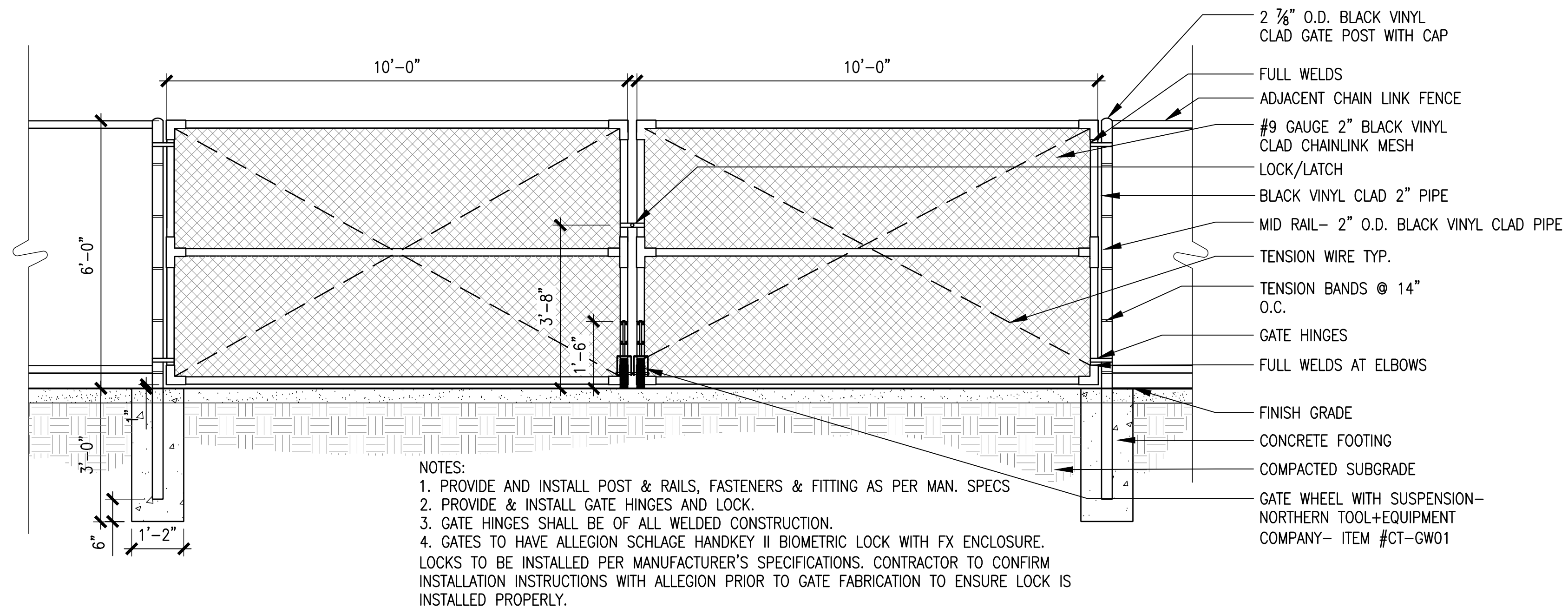

- NOTES:
1. PROVIDE AND INSTALL POST & RAILS, FASTENERS & FITTING AS PER MAN. SPECS
 2. PROVIDE & INSTALL GATE HINGES AND LOCK.
 3. GATE HINGES SHALL BE OF ALL WELDED CONSTRUCTION.
 4. GATES TO HAVE ALLEGION SCHLAGE HANDKEY II BIOMETRIC LOCK WITH FX ENCLOSURE. LOCKS TO BE INSTALLED PER MANUFACTURER'S SPECIFICATIONS. CONTRACTOR TO CONFIRM INSTALLATION INSTRUCTIONS WITH ALLEGION PRIOR TO GATE FABRICATION TO ENSURE LOCK IS INSTALLED PROPERLY.

A CHAIN LINK VEHICULAR GATE

SCALE: 1/2"=1'-0"

REV.	COMMENT	DATE
1	FENCING UPDATE	5/24/23
2	LANDSCAPE NOTES UPDATE	5/3/23
3	LANDSCAPE NOTES: FENCE UPDATE	6/15/23

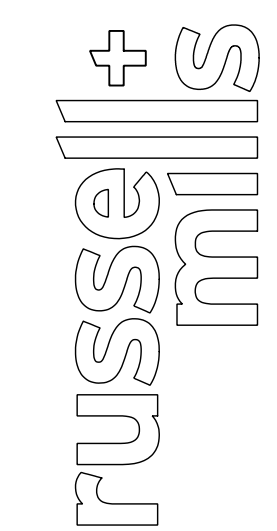

FOSSIL CREEK RANCH
 FILING 2
 Final Landscape Details

Date: SEPT 2020
 Drawn By: MT
 Checked By: JB

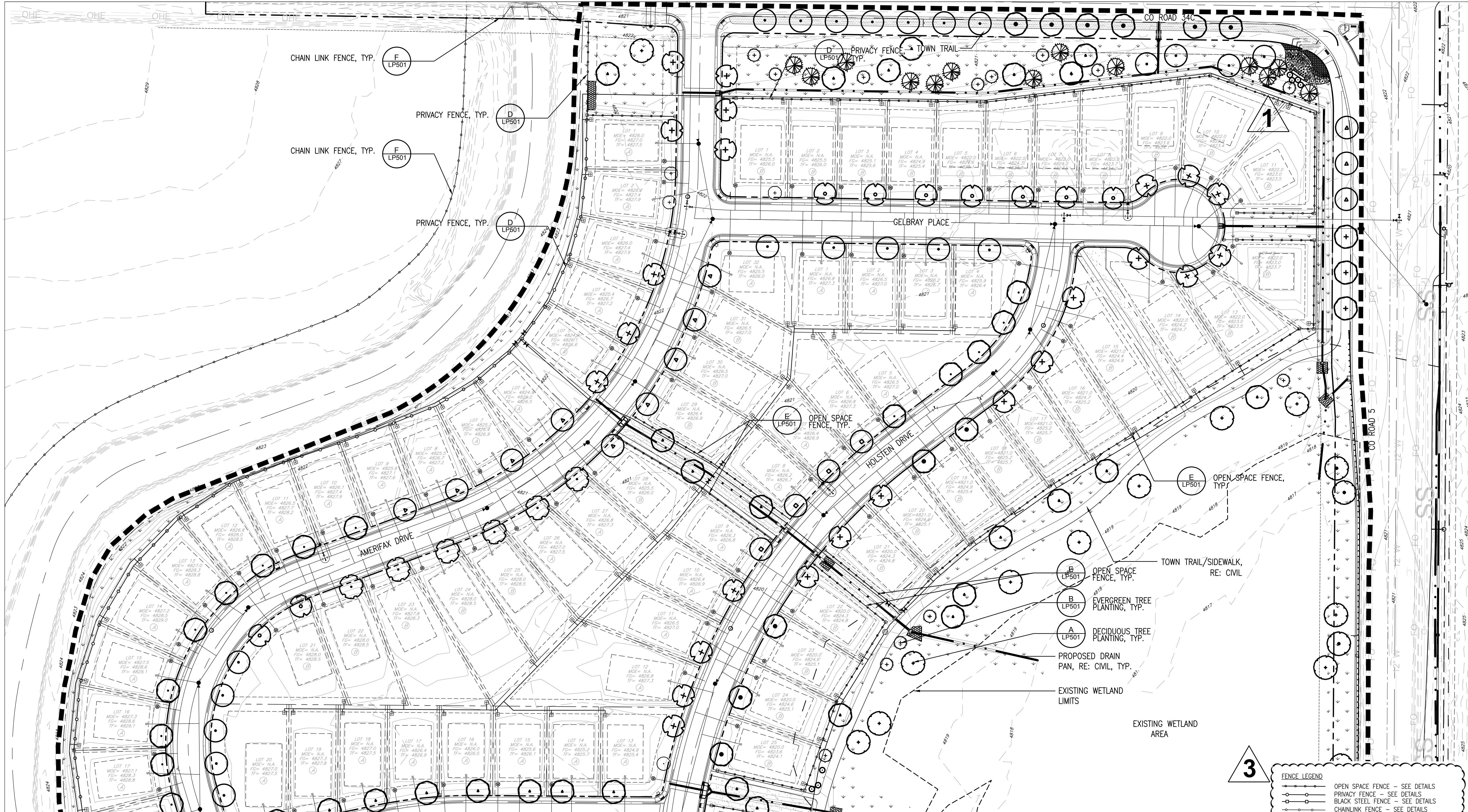

REV.	COMMENT	DATE
1	MONUMENT SIGNAGE LANDSCAPE	9/27/22
2	LANDSCAPE NOTES UPDATE	5/3/23
3	LANDSCAPE NOTES, FENCE UPDATE	6/15/23

LANDSCAPE LEGEND:

	80/20 FESCUE/BLUEGRASS MIX SOD - (INCLUDES SOD BETWEEN ROW AND BACK OF WALK) - 31,730 SF		NATIVE SEED MIX - 371,208 SF
	80/20 FESCUE/BLUEGRASS SEEDDED TURF - 20,563 SF		DETENTION SEED MIX - 40,319 SF
	SHRUB PLANTING - 7,612 SF		OPEN SPACE: 321,571 S.F. - 37%
	PUBLIC STREET: 218,255 S.F. - 25%		SIDEWALK & PATHWAYS: 337,576 S.F. - 38%

LANDSCAPE SCHEDULE

QTY	SYMBOL	%	ID	BOTANIC NAME	COMMON NAME	SIZE
DECIDUOUS TREES						
18		4.8%	CSP	CATALPA SPECIOSA	NORTHERN CATALPA	2" CAL.
17		4.5%	COC	CELTIS OCCIDENTALIS	HACKBERRY	2" CAL.
18		4.8%	GTR	GLEDTISIA TRIACANTHOS INERMIS 'SHADEMASTER'	SHADEMASTER HONEYLOCUST	2" CAL.
20		5.3%	GIN	GLEDTISIA TRIACANTHOS INERMIS 'SKYCOLE'	SKYLINE HONEYLOCUST	2" CAL.
10		8.0%	GDI	GYMNOCLADUS DIOICA 'EXPRESSO'	EXPRESSO KENTUCKY COFFEETREE	2" CAL.

10		2.7%	PAN	POPULUS ANGUSTIFOLIA	NARROWLEAF COTTONWOOD	2" CAL.
28		7.5%	PSA	POPULUS SARGENTII (NOT USED AS STREET TREE)	PLAINS COTTONWOOD	2" CAL.
14		3.7%	QBU	QUERCUS BUCKLEYI	TEXAS RED OAK	2" CAL.
24		6.7%	QMA	QUERCUS MACROCARPA (BULLET GALL RESISTANT)	BUR OAK	2" CAL.
14		3.7%	QME	QUERCUS MEUHLIENBERGII	CHINKAPIN OAK	2" CAL.
41		10.9%	TAM	TILIA AMERICANA 'SENTRY'	AMERICAN SENTRY LINDEN	2" CAL.
20		5.3%	TCO	TILIA CORDATA 'GREENSPIRE'	GREENSPIRE LINDEN	2" CAL.

QTY	SYMBOL	%	ID	BOTANIC NAME	COMMON NAME	SIZE
33		3.7%	UAC	ULMUS 'ACCOLADE'	ACCOLADE ELM	2" CAL.
ORNAMENTAL TREES						
10		2.7%	MSP	MALUS 'SPRING SNOW'	SPRING SNOW CRABAPPLE	1.5" CAL.
6		1.6%	MTH	MALUS 'THUNDERCHILD'	THUNDERCHILD CRABAPPLE	1.5" CAL.
6		1.6%	PCA	PYRUS CALLERYANA	CHANTICLEER PEAR	1.5" CAL.
23		6.1%	JSO	JUNIPERUS SCOPULORUM	ROCKY MTN. JUNIPER	6' HT.

SHRUBS - SYMBOLS SCALED LARGER FOR CLARITY

13			CSE	CORNUS SERICEA	ISANTI DOGWOOD	5 GAL.
19			CLA	CARYOPTERIS X CLANDONENSIS	BLUE MIST SPIREA	5 GAL.
ORNAMENTAL GRASSES - SYMBOLS SCALED LARGER FOR CLARITY						
22			MPU	MISCANTHUS 'PURPURANSCEUS'	FLAME MAIDEN GRASS	1 GAL.
25			PAL	PENNISETUM ALOPECUROIDES 'HAMLEN'	CHINESE FOUNTAIN GRASS	1 GAL.
44			SHE	SPOROBOLUS HETEROLEPIS	PRAIRIE DROP SEED	1 GAL.

FENCE LEGEND

	OPEN SPACE FENCE - SEE DETAILS
	PRIVACY FENCE - SEE DETAILS
	BLACK STEEL FENCE - SEE DETAILS
	CHAINLINK FENCE - SEE DETAILS

FINAL LANDSCAPE ENLARGEMENT PLAN

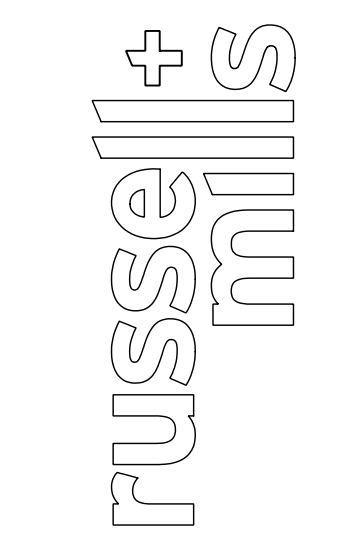
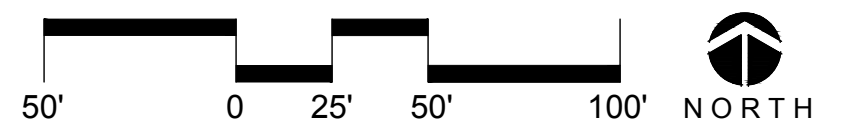

FOSSIL CREEK RANCH
Final Landscape Enlargement Plan
FOR CONSTRUCTION

Date: 12/7/2022
 Drawn By: MT
 Checked By: JB

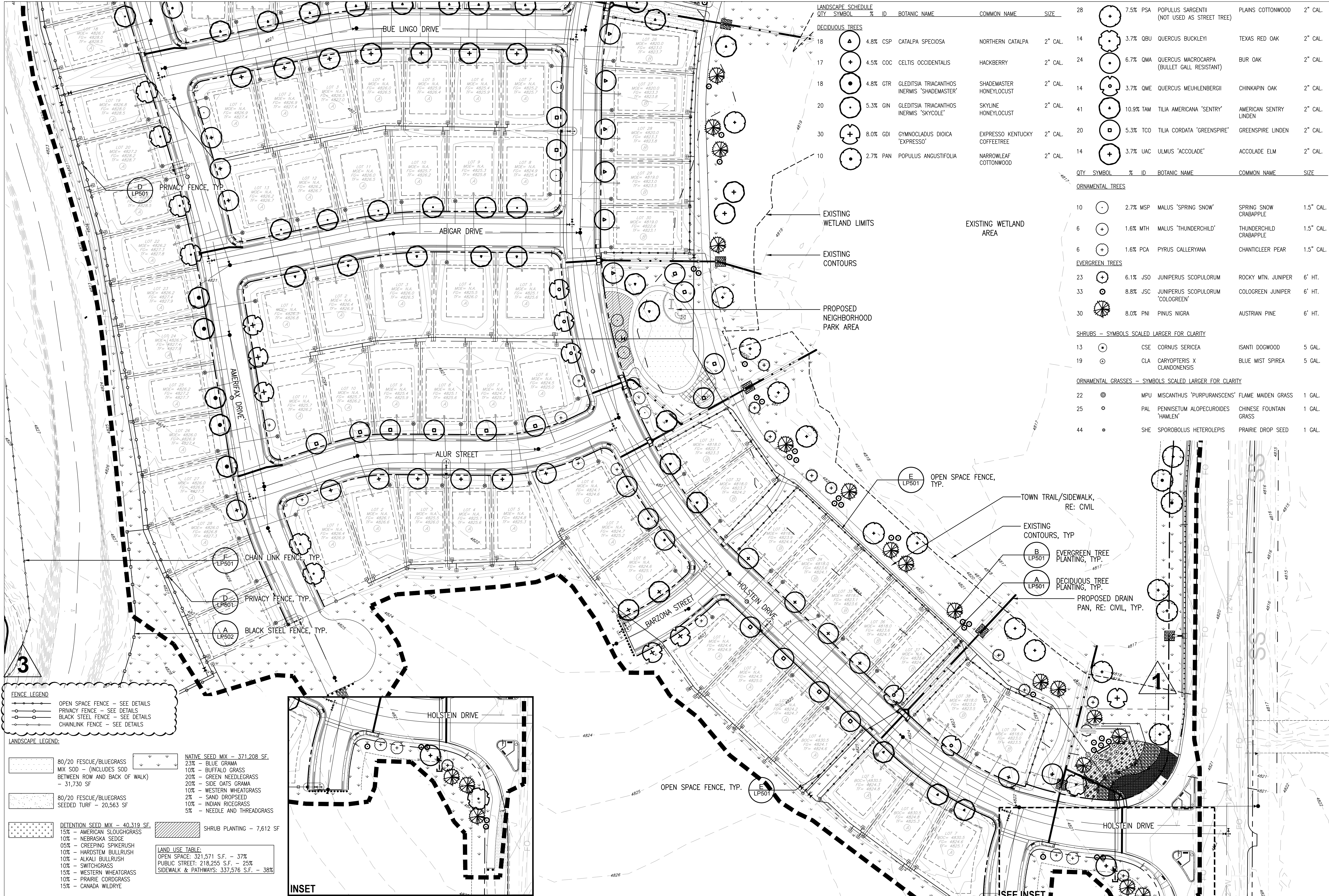

LANDSCAPE SCHEDULE		QTY	%	ID	BOTANIC NAME	COMMON NAME	SIZE
DECIDUOUS TREES							
18	▲	4.8%	CSP	CATALPA SPECIOSA	NORTHERN CATALPA	2" CAL.	
17	+	4.5%	COC	CELTIS OCCIDENTALIS	HACKBERRY	2" CAL.	
18	●	4.8%	GTR	GLEDTISIA TRIACANTHOS INERMIS 'SHADEMASTER'	SHADEMASTER HONEYLOCUST	2" CAL.	
20	○	5.3%	GIN	GLEDTISIA TRIACANTHOS INERMIS 'SKYCOLE'	SKYLINE HONEYLOCUST	2" CAL.	
30	+	8.0%	GDI	GYMNOCLADUS DIOICA 'EXPRESSO'	EXPRESSO KENTUCKY COFFEETREE	2" CAL.	
10	●	2.7%	PAN	POPULUS ANGUSTIFOLIA	NARROWLEAF COTTONWOOD	2" CAL.	
ORNAMENTAL TREES							
10	○	2.7%	MSP	MALUS 'SPRING SNOW'	SPRING SNOW CRABAPPLE	1.5" CAL.	
6	+	1.6%	MTH	MALUS 'THUNDERCHILD'	THUNDERCHILD CRABAPPLE	1.5" CAL.	
6	+	1.6%	PCA	PYRUS CALLERYANA	CHANTICLEER PEAR	1.5" CAL.	
EVERGREEN TREES							
23	+	6.1%	JSO	JUNIPERUS SCOPULORUM	ROCKY MTN. JUNIPER	6' HT.	
33	○	8.8%	JSC	JUNIPERUS SCOPULORUM 'COLOGREEN'	COLOGREEN JUNIPER	6' HT.	
30	●	8.0%	PNI	PINUS NIGRA	AUSTRIAN PINE	6' HT.	
SHRUBS - SYMBOLS SCALED LARGER FOR CLARITY							
13	○		CSE	CORNUS SERICEA	ISANTI DOGWOOD	5 GAL.	
19	○		CLA	CARYOPTERIS X CLANDONENSIS	BLUE MIST SPIREA	5 GAL.	
ORNAMENTAL GRASSES - SYMBOLS SCALED LARGER FOR CLARITY							
22	○		MPU	MISCANTHUS 'PURPURASCENS'	FLAME MAIDEN GRASS	1 GAL.	
25	○		PAL	PENNISETUM ALOPECUROIDES 'HAMLEN'	CHINESE FOUNTAIN GRASS	1 GAL.	
44	○		SHE	SPOROBOLUS HETEROLEPIS	PRAIRIE DROP SEED	1 GAL.	

REV.	COMMENT	DATE
1	MONUMENT SIGNAGE LANDSCAPE	9/27/22
2	LANDSCAPE NOTES UPDATE	5/3/23
3	LANDSCAPE NOTES, FENCE UPDATE	6/15/23

FENCE LEGEND

- OPEN SPACE FENCE - SEE DETAILS
- PRIVACY FENCE - SEE DETAILS
- BLACK STEEL FENCE - SEE DETAILS
- ▨ CHAINLINK FENCE - SEE DETAILS

LANDSCAPE LEGEND:

80/20 FESCUE/BLUEGRASS MIX SOD - (INCLUDES SOD BETWEEN ROW AND BACK OF WALK) - 31,730 SF	NATIVE SEED MIX - 371,208 SF
80/20 FESCUE/BLUEGRASS SEEDED TURF - 20,563 SF	23% - BLUE GRAMA
DETENTION SEED MIX - 40,319 SF	10% - BUFFALO GRASS
15% - AMERICAN SLOUGHGRASS	20% - GREEN NEEDLEGRASS
10% - NEBRASKA SEDGE	20% - SIDE OATS GRAMA
05% - CREEPING SPIKERUSH	10% - WESTERN WHEATGRASS
10% - HARDSTEM BULLRUSH	2% - SAND DROPSSEED
10% - ALKALI BULLRUSH	10% - INDIAN RICEGRASS
10% - SWITCHGRASS	5% - NEEDLE AND THREADGRASS
15% - WESTERN WHEATGRASS	SHRUB PLANTING - 7,612 SF
10% - PRAIRIE CORDGRASS	
15% - CANADA WILDRYE	

LAND USE TABLE:

OPEN SPACE: 321,571 S.F. - 37%
PUBLIC STREET: 218,255 S.F. - 25%
SIDEWALK & PATHWAYS: 337,576 S.F. - 38%

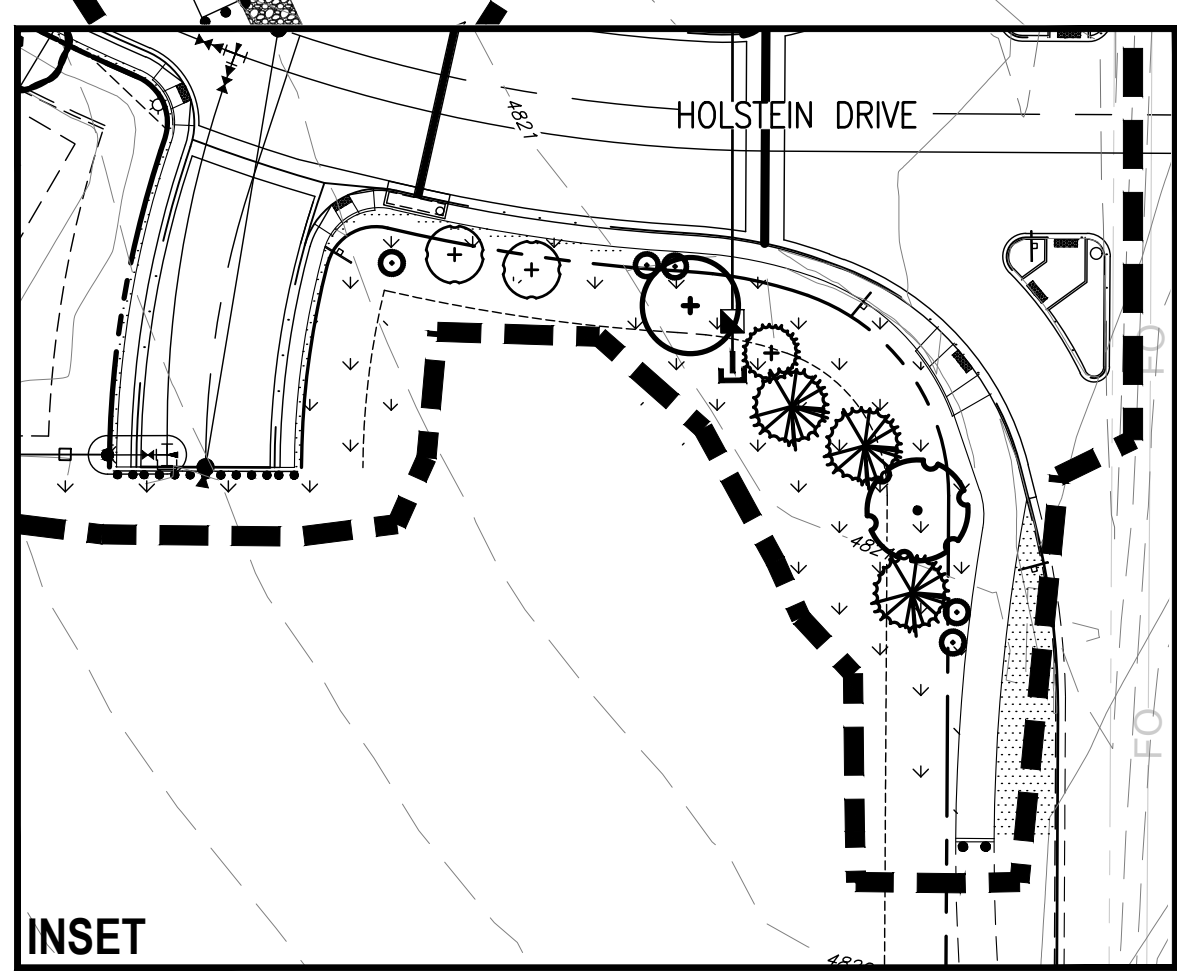

russe+lls mills

FOSSIL CREEK RANCH
Final Landscape Enlargement Plan
FOR CONSTRUCTION

Date: 12/7/2022
Drawn By: MT
Checked By: JB

Sheet

REV.	COMMENT	DATE
1	MONUMENT SIGNAGE LANDSCAPE	9/27/22
2	LANDSCAPE NOTES UPDATE	5/3/23
3	LANDSCAPE NOTES FENCE UPDATE	6/15/23

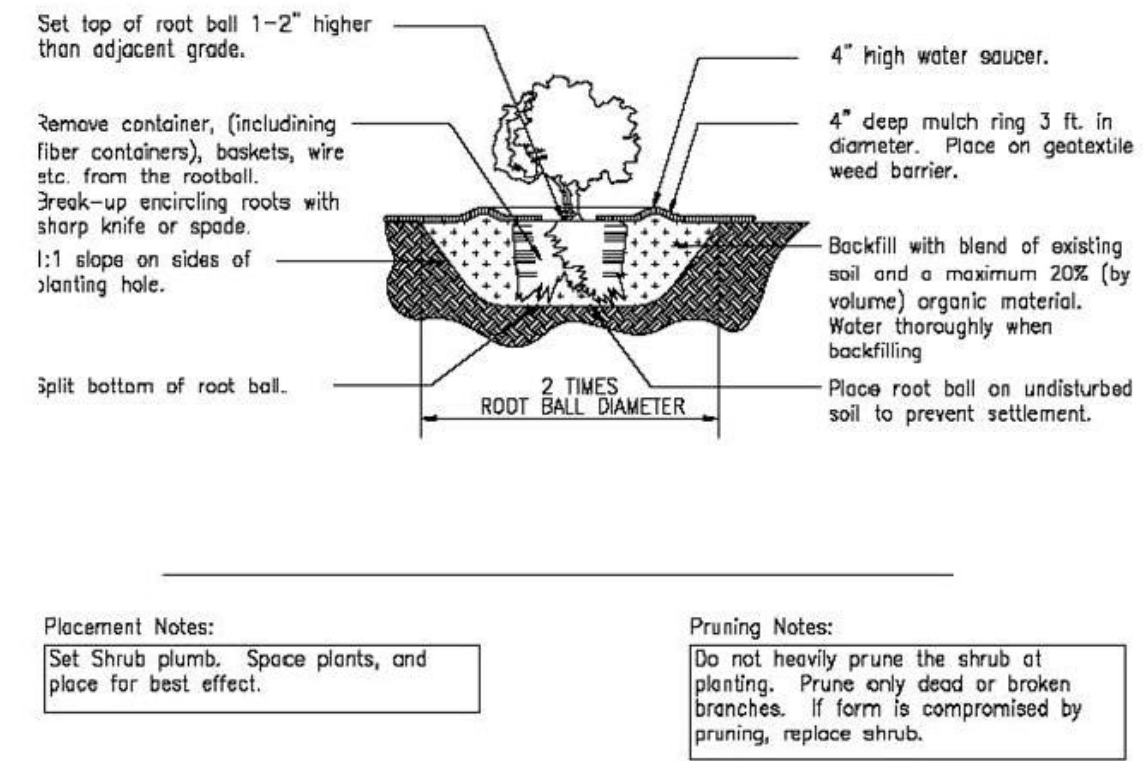
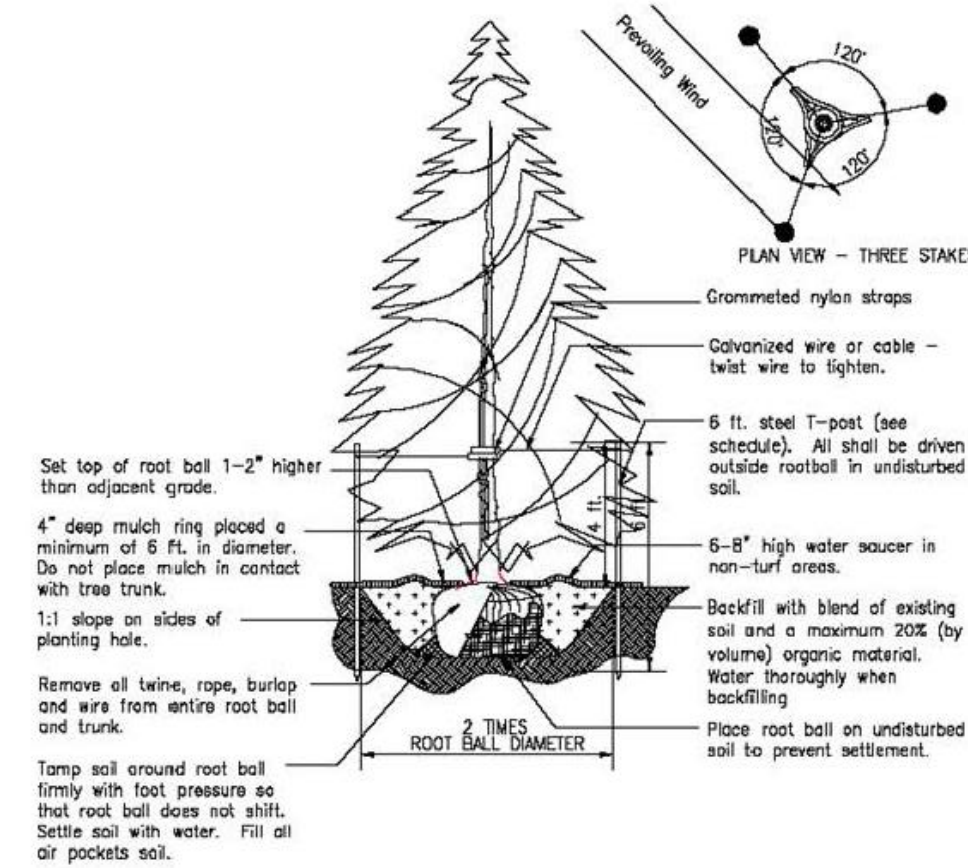
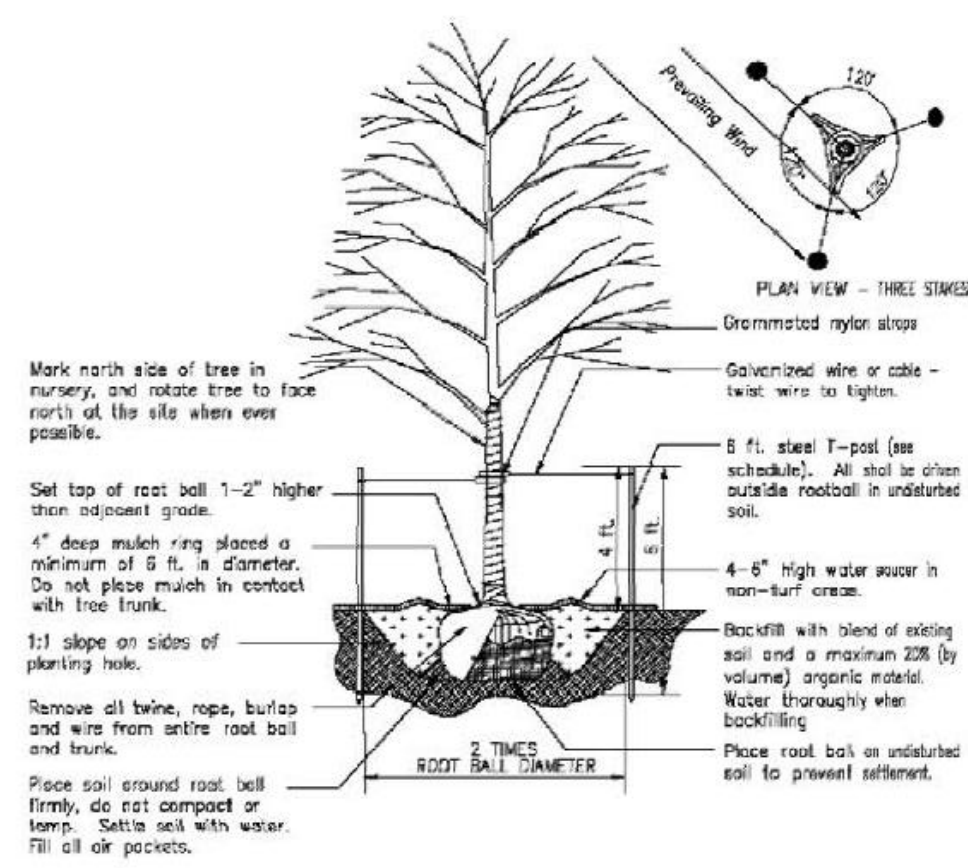

Placement Notes:
 Set Shrub plants. Space plants, and place for best effect.

Pruning Notes:
 Do not heavily prune the shrub at planting. Prune only dead or broken branches. If form is compromised by pruning, replace shrub.

A DECIDUOUS TREE PLANTING
 SCALE: NTS

B EVERGREEN TREE PLANTING
 SCALE: NTS

C SHRUB PLANTING
 SCALE: NTS

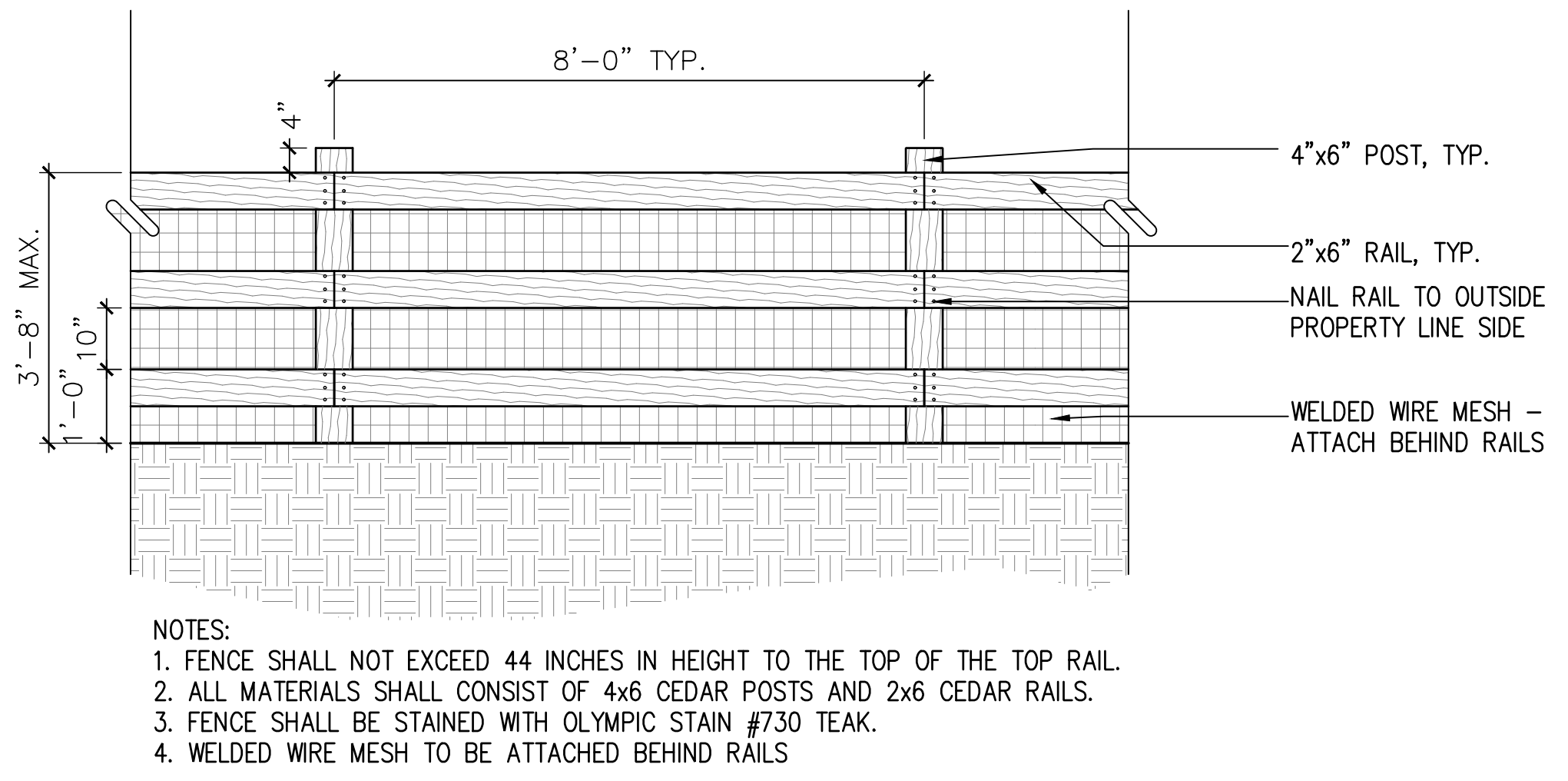
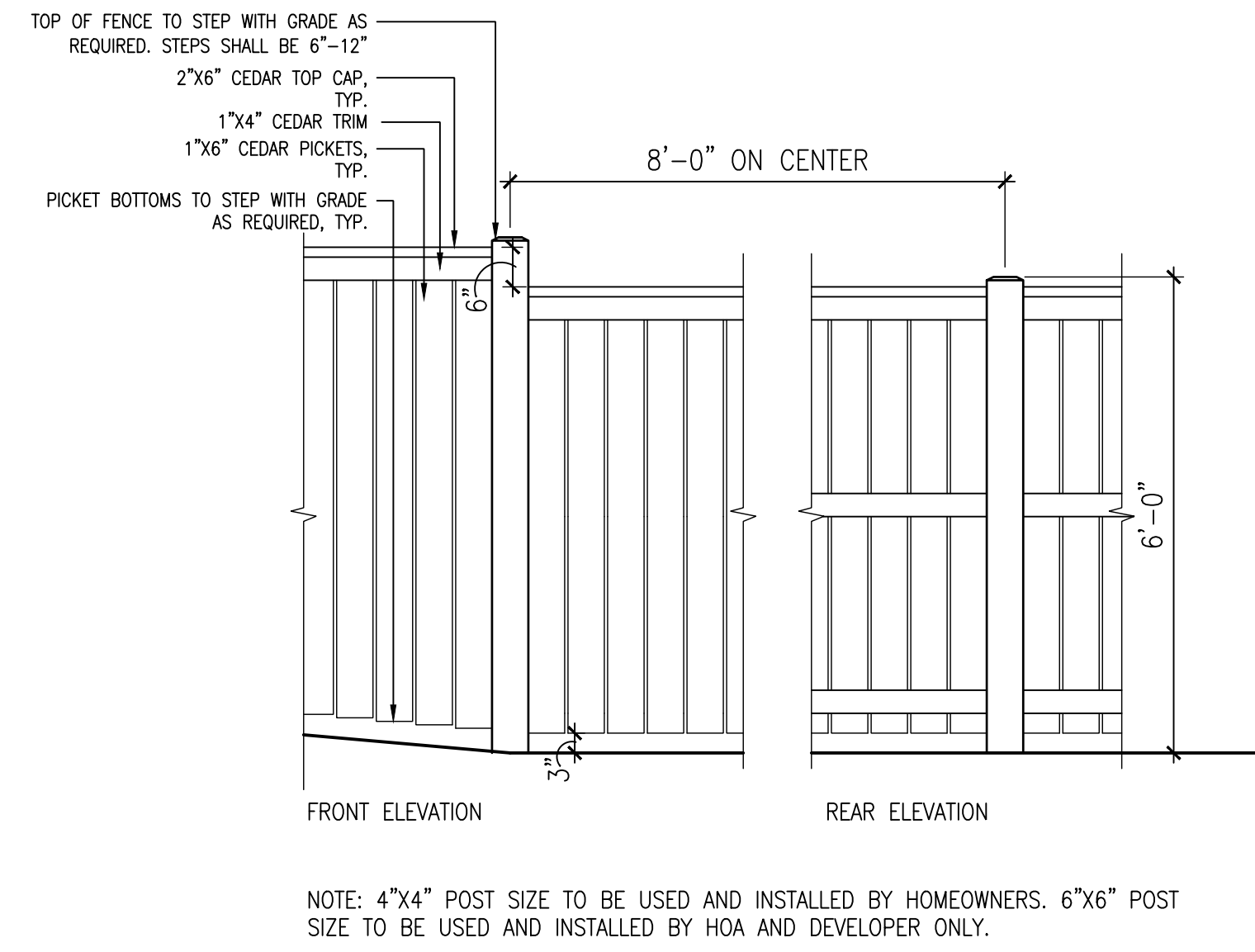

D 6' PRIVACY FENCE
 SCALE: 1/2"=1'-0"

E OPEN SPACE FENCE
 SCALE: 1/2"=1'-0"

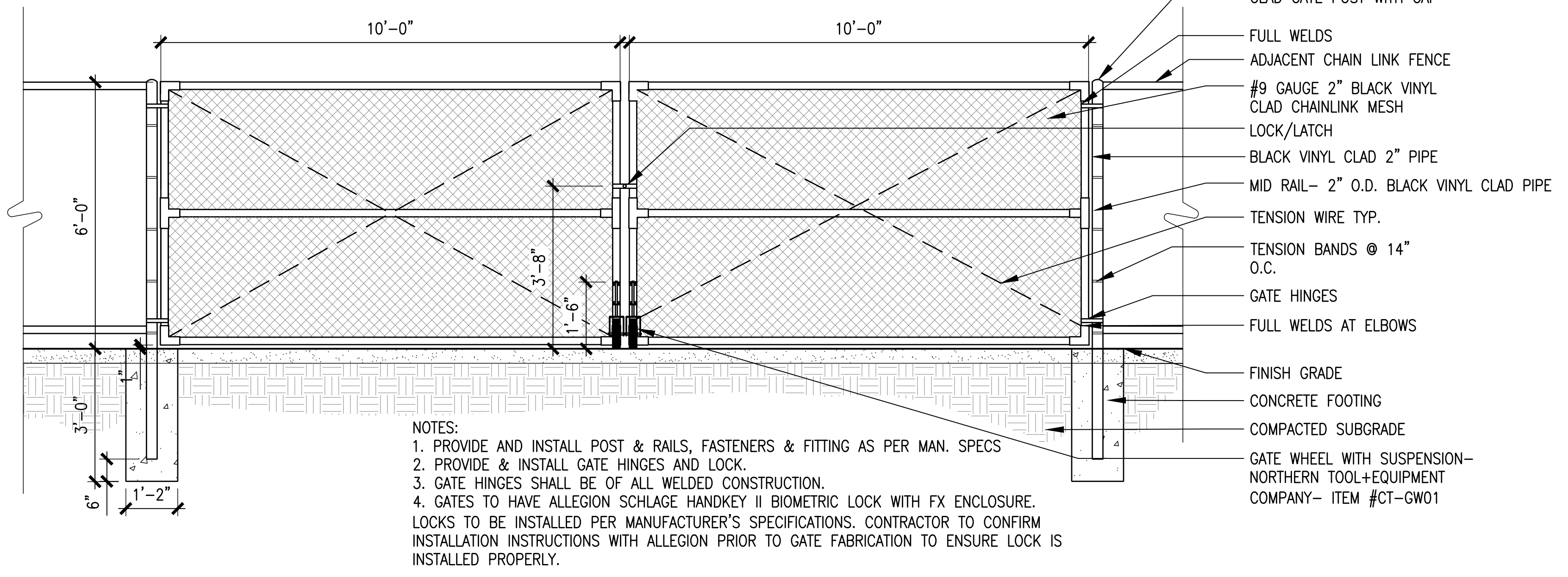
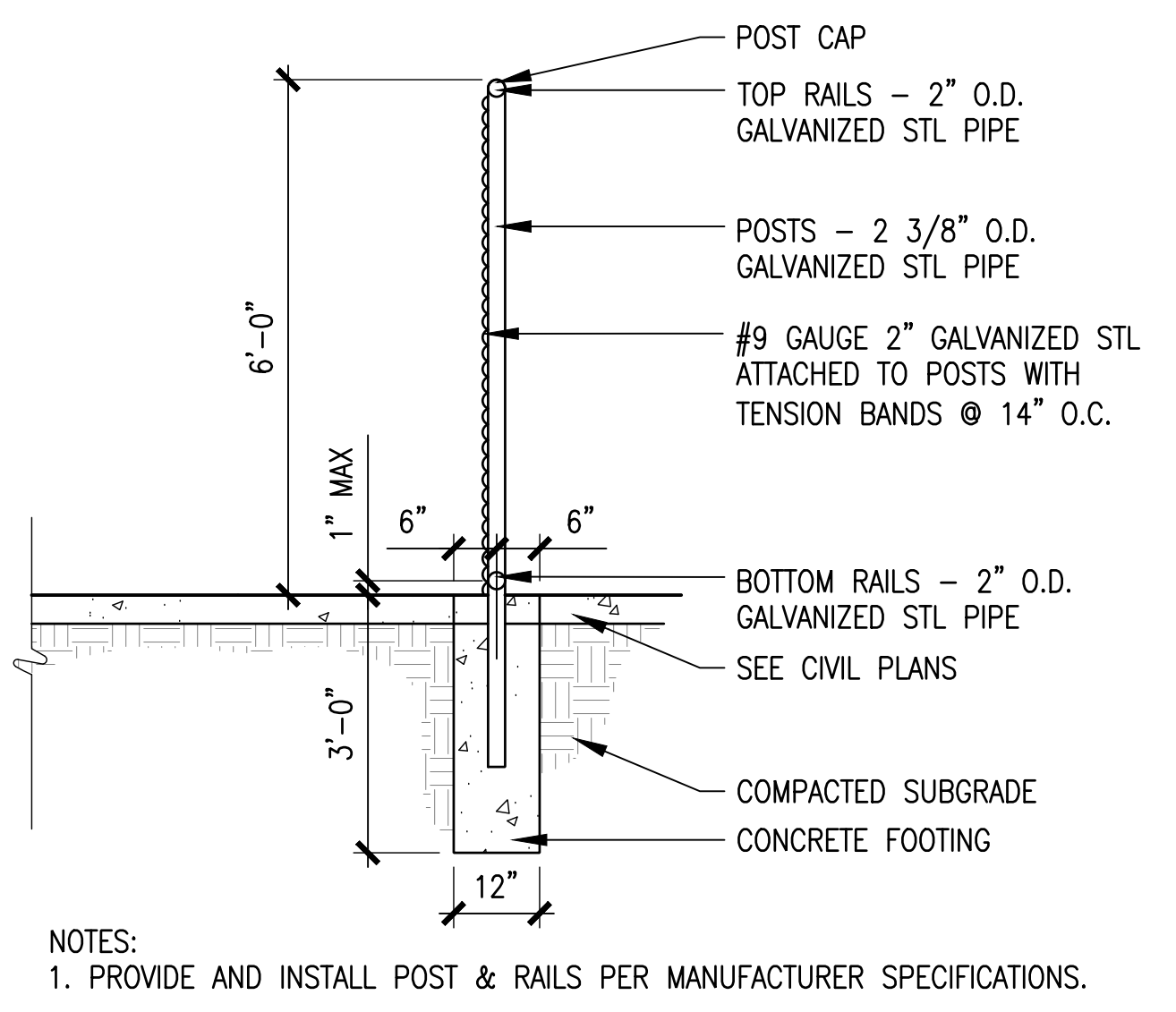

F 6' CHAINLINK FENCE
 SCALE: 1/2"=1'-0"

G CHAIN LINK VEHICULAR GATE
 SCALE: 1/2"=1'-0"

russell+mills

FOSSIL CREEK RANCH
 Final Landscape Enlargement Plan
 FOR CONSTRUCTION

Date: 12/7/2022
 Drawn By: MT
 Checked By: JB



COMPANY: AMERISTAR FENCING
 MODEL: MONTAGE
 STYLE: MAJESTIC, WITH FLUSH BOTTOM RAIL,
 MATCHING GATE
 COLOR: BLACK
 HEIGHT: 6 FT.
 CONTACT: 1-888-333-3422
 (WWW.AMERISTARFENCING.COM)
 INSTALL PER MANUFACTURER RECOMMENDATIONS
 AND SPECIFICATIONS.

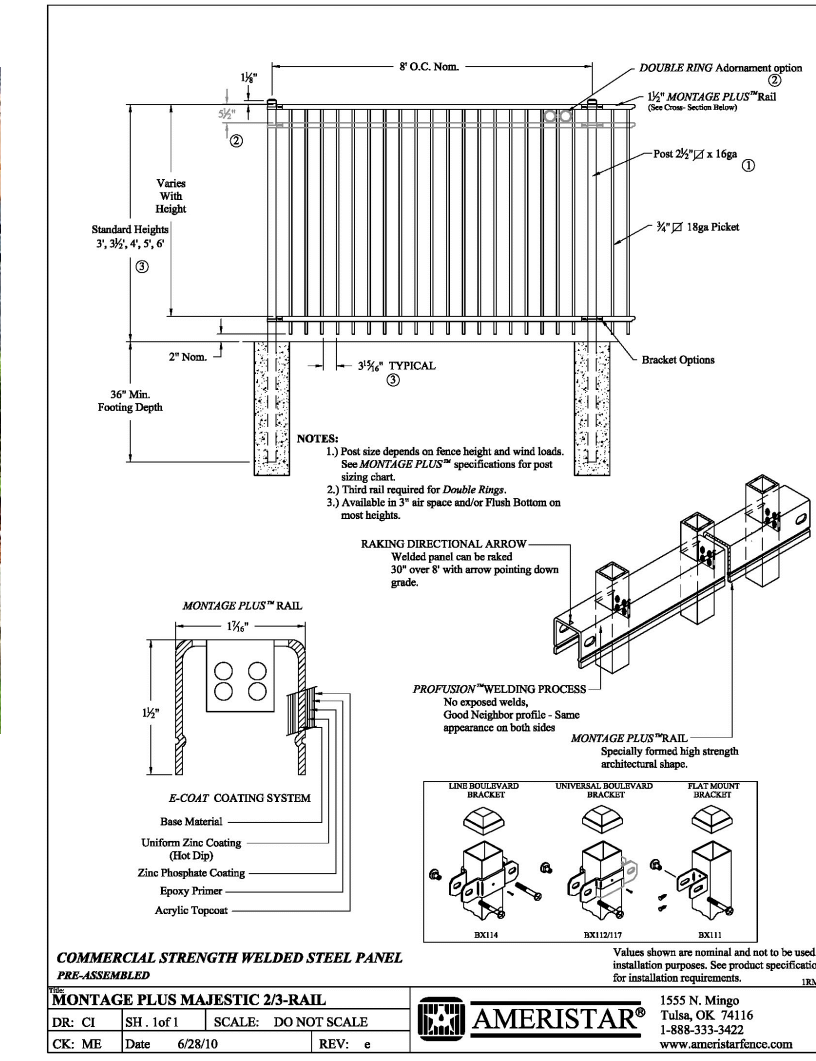

AMERISTAR STANDARD FENCE DETAIL

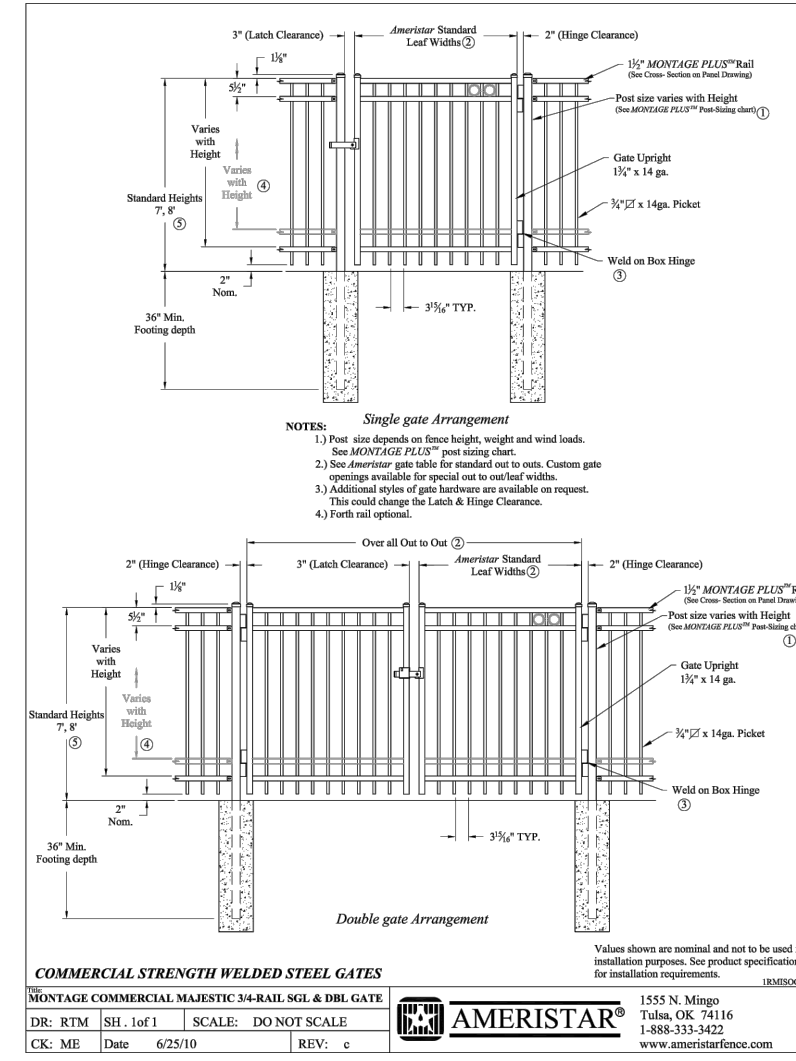

AMERISTAR STANDARD GATE DETAIL

SIZES:
 - (4) 4' PERSON GATE WITH BIOMETRIC LOCK
 - (4) 10' VEHICULAR GATE WITH BIOMETRIC LOCK

NOTE: GATES TO HAVE ALLEGION SCHLAGE HANDKEY II BIOMETRIC LOCK WITH FX ENCLOSURE. LOCKS TO BE INSTALLED PER MANUFACTURER'S SPECIFICATIONS. CONTRACTOR TO CONFIRM INSTALLATION INSTRUCTIONS WITH ALLEGION PRIOR TO GATE FABRICATION TO ENSURE LOCK IS INSTALLED PROPERLY.

A BLACK STEEL FENCING
 SCALE: NTS

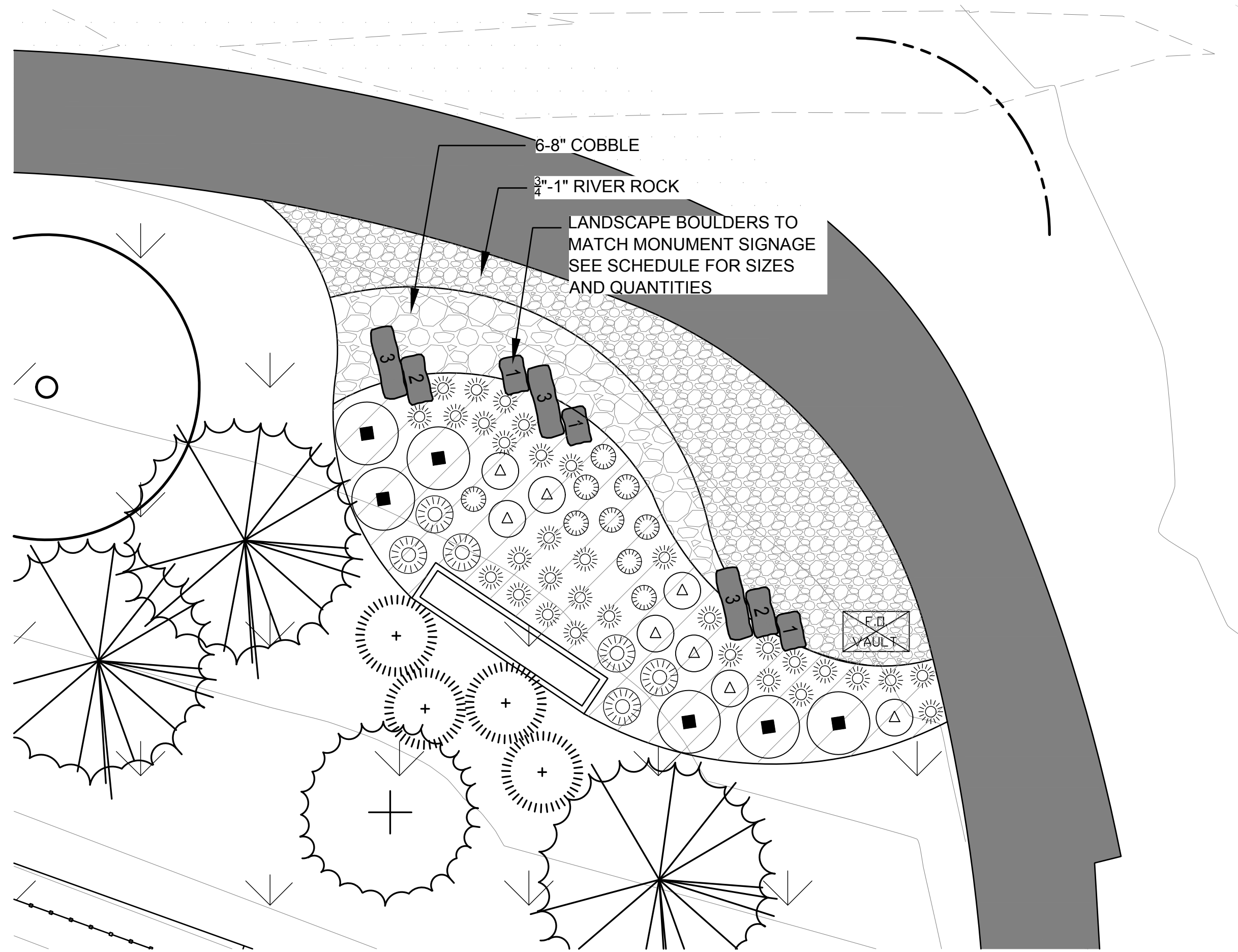

B NORTH MONUMENT SIGN - LANDSCAPE ENLARGEMENT PLAN
 SCALE: 1/8"=1'-0"
 FILENAME

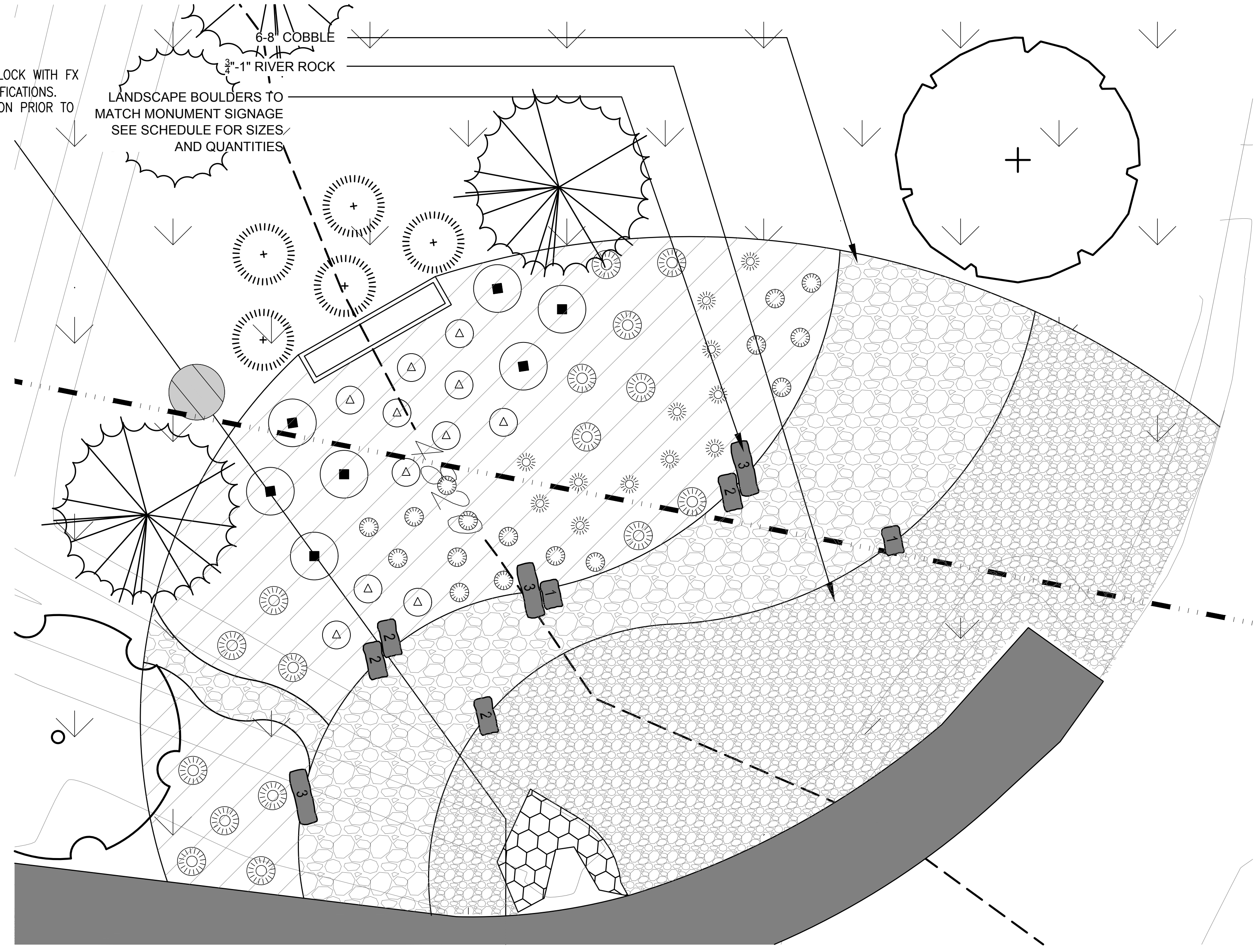

C SOUTH MONUMENT SIGN - LANDSCAPE ENLARGEMENT PLAN
 SCALE: 1/8"=1'-0"
 FILENAME

1

REV.	COMMENT	DATE
1	MONUMENT SIGNAGE LANDSCAPE	9/27/22
2	LANDSCAPE NOTES UPDATE	5/3/23
3	LANDSCAPE NOTES, FENCE UPDATE	6/15/23

russell+ mills

FOSSIL CREEK RANCH
 Final Landscape Enlargement Plan
 FOR CONSTRUCTION

Date: 12/7/2022
 Drawn By: MT
 Checked By: JB

Sheet

- B. Wing Fence: Fence shall be 6-foot, cedar privacy fences. Fence shall be stained with Olympic stain #730 Teak.

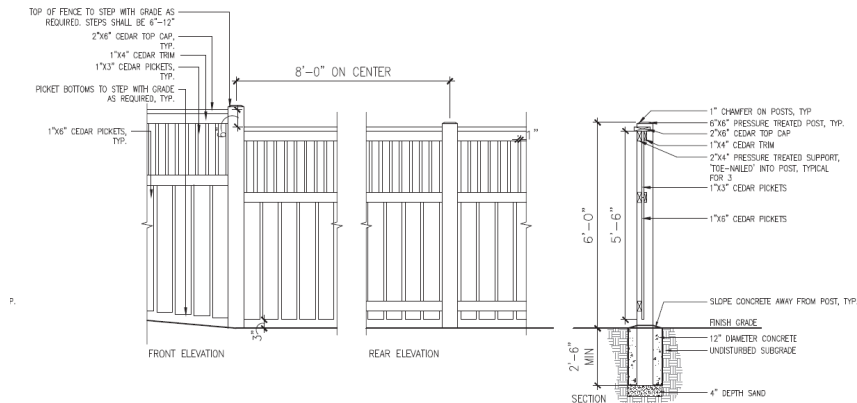

- C. Where fences of differing heights abut, the taller fence shall taper (at a maximum 2:1 ratio) to the height of the lower fence. Internal lot fencing shall be cedar privacy or rail and shall be of consistent design. If privacy fence is installed it shall taper (at a maximum 2:1 ratio) to the height of the approved rail fence or existing fence where it joins a common property line.
- D. Privacy fencing shall have 4-inch cedar pickets.

2.27 **Firewood Storage. See Wood Storage Section 2.86.**

2.28 **Flag/Flagpoles.** Approval is not required for flagpoles mounted to the front of the residence. Under no circumstance may the height of the flagpole exceed the height of the roofline of the residence with a maximum length of six (6) feet.

Approval by the ACC is required prior to installing vertical, freestanding flagpoles. Freestanding flagpoles may only be installed in the front or back yard area of a lot and are limited to 20 feet (20'). The height of the pole includes any top caps (ball, eagle, etc.) on the pole. All freestanding flagpoles with flags flying 24 hours a day shall be lit to meet U.S. Flag Code with any lighting being directed at the flag, with no brighter than a 15 to 20-watt LED flagpole light fixture.

No flag shall exceed 20 square feet in surface area. All flags shall be displayed and maintained in good condition.

2.29 **Garbage Containers and Storage Areas. See Trash Containers, Enclosures and Pickup Section 2.77.**

2.30 **Gardens-Flower or Vegetable.** Approval is not required for flower or vegetable gardens that do not exceed 100 total square feet. All flower gardens must be weeded, cared for and maintained. Vegetable gardens should be in the rear or side yard.

2.31 **Gazebos.** Approval is required. A gazebo must be an integral part of the rear yard landscape

plan. A gazebo must be similar in material and design to the residence and the color must be generally accepted as a complementary color to the exterior of the residence.

- 2.32 **Grading and Grade Changes. See Drainage. Section 2.22.**
- 2.33 **Greenhouses.** Approval is required. Generally, greenhouses will be discouraged due to the extensive maintenance required and the overall visual impact to neighboring lots. Approval will be based upon but not limited to general aesthetics, quality and permanence of materials used. Adequate screening will be required.
- 2.34 **Hanging of Clothes. See Clotheslines and Hangers Section 2.15.**
- 2.35 **Hot Tubs and Jacuzzis.** Approval is required. Must be an integral part of the deck or patio area and of the rear yard landscaping. Must be installed in such a way that it does not create an unreasonable level of noise for adjacent property owners. In some instances, additional plant material, around the hot tub, may be required for screening.
- 2.36 **Irrigation Systems.** Underground automatic irrigation systems will not require approval. All homes must have an underground automatic irrigation system installed with the landscape. Owners must comply with the District's Irrigation Water Rules and Regulations, as may be amended from time to time. For recommended irrigation system treatment, **See Irrigation Section 4.9.**
- 2.37 **Jacuzzis. See Hot Tubs and Jacuzzis Section 2.35.**
- 2.38 **Kennels.** Breeding or maintaining animals for a commercial purpose is prohibited. See **2.20 Dog Runs.**
- 2.39 **Landscaping.** Approval is required. **The first owner of each lot (other than the Declarant or a builder) shall install landscaping on such lot no later than one-hundred and eighty (180) days from the closing with the exception of closings that occur between October 1st and April 1st. Owners with closings that occur between October 1st and April 1st shall be required to complete landscaping before the following October 1st.** Landscaping plans must be submitted to the Architectural Review Committee for review and approval prior to the installation of landscaping, except where installed by the Declarant or a builder as provided in the Declaration. Each owner shall maintain all landscaping on such owner's lot in a neat and attractive condition, including periodic and horticulturally correct pruning, removal of weeds and debris, and replacement of landscaping. All landscape plan submittals must clearly and professionally demonstrate, to scale, the proposed landscape installation. The plot plan of the residence and yard must be provided. All organic materials (plants, shrubs, trees, etc.), building materials (stone, wood, edging, etc.), must be clearly labeled in detail. Providing material samples is suggested.
- A. Irrigation. All landscaping shall include automatic irrigation. **See Irrigation Sections. 2.36 and 4.9.**
- B. Plant Material Location and Sizes. Landscaping shall consist of trees, shrubs, ground

covers, annual and perennial flowers, turf grasses, mulches and automatic irrigation. **In the case of shade or ornamental trees (deciduous), plantings cannot be installed closer than 6 feet (6') from the property line. In the case of evergreen trees (conifer), plantings cannot be installed closer than 10 feet (10') from the property line.** Select a variety of plant species including deciduous and evergreen trees and shrubs. All plant material shall be installed in the following minimum sizes:

1. Shade trees - 2½" caliper
 2. Ornamental trees - 2" caliper
 3. Evergreen trees - 6' height minimum
 4. All shrubs – 5-gallon container
 5. Groundcover, annuals, and perennials - no restrictions
- C. As an alternative to traditional landscaping, xeriscaping is water conservation planning through creative landscaping. Please remember that xeriscaping requires as much or more maintenance as traditional landscaping. All xeriscape plans must incorporate the installation of a properly functioning irrigation system to help maintain the plantings.
- D. Maintenance. Once installed, the landscaping, including the landscaping in the “tree lawn” area between the sidewalk and the street, must be maintained in a neat, slightly, and weed free condition by the owner.

2.40 **Latticework.** Approval is required for any type of trellis or latticework.

2.41 **Lights and Lighting.** Approval is required for all exterior lighting. Exterior lights must be conservative in design and be as small as reasonably practical. Exterior lighting should be directed toward the ground and be of low wattage to minimize the glare to neighbors and other homeowners. Lighting for walkways generally should be placed on wooden standards and lighting fixtures should be dark colored so as to be less obtrusive. The use of motion detector spotlights, high-wattage spotlights or floor lights, ballasted fixtures (sodium, mercury, multi-vapor, fluorescent, metal halide, etc.) require approval. For additional information regarding **Holiday Lighting see Seasonal Decorations Section 2.60.**

2.42 **Microwave Dishes. See Antennae Section 2.07.**

2.43 **Overhangs/Awnings Cloth or Canvas.** Approval is required. An overhang should be an integral part of the house or patio design. The color must be the same as, or generally recognized as, a complementary color to the exterior of the residence. Must provide swatch of material to be used. See also, Patio Covers Section 2.45.

2.44 **Painting.** Approval is not required if color and/or color combinations are identical to the original color established on the home. Any changes to the color scheme or color changes must be submitted for approval and must conform to the general scheme of the community.

To submit color changes for the home, submit the Architectural Request Form with the color samples painted on a hard surface which is at least 12" x 12", with a photos of the colors of the house on either side of your home to the Architectural Review Committee.

2.45 **Patio Covers.** Patio covers must be constructed of material consistent with the home and be similar or generally recognized as complementary in color to the colors on the house. Freestanding patio covers may be permitted as well as extensions of the roof.

- 2.46 **Patios (Enclosed).** See Additions and Expansions Section 2.03.
- 2.47 **Patios (Open).** Open patios must be an integral part of the landscape plan and must be located so as not to create an unreasonable level of noise for adjacent property owners. In some instances, additional plant material, around the patio, may be required for screening. The patio and materials must be similar or generally accepted as a complementary color and design to the residence.
- 2.48 **Paving.** Approval is required for the paving of all walks, patio areas, or other purposes and for all materials used, including concrete, brick, flagstones, steppingstones, pre-cast patterned or exposed aggregate concrete pavers. Asphalt will not be allowed. See Driveways Section 2.23.
- 2.49 **Pipes.** See Utility Equipment Section 2.80.
- 2.50 **Play Structures and Sports Equipment.** Approval is not required if structure or equipment is under six feet (6') in height or moveable (bounce-back, net, etc.). Any items over six feet (6') in height require approval. Consideration will be given to adjacent properties (a min. 5-foot setback from the property line, for trampolines, swing sets, fort structures, etc.) so as not to create an undue disturbance. In some instances, additional plant material, around the equipment, may be required for screening. Wood structures should be constructed of pressure treated or other weather resistant materials. All play and sports equipment must be maintained in a good and sightly manner. The use of multi-rainbow-colored cloth/canvas tarps is discouraged.
- 2.51 **Playhouses.** A structure more than 24 square feet and/or over six feet high requires approval. All playhouses must match the home in both color and materials.
- 2.52 **Poles.** See Flagpoles Section 2.28 and Utility Equipment, Section 2.80.
- 2.53 **Pools.** Pools must be placed in the rear yard and be an integral part of the deck or patio area. They should be located in such a way that they are not immediately visible to adjacent property owners (i.e. screened with plant material). Above ground pools are prohibited. See Hot Tubs and Jacuzzis Section 2.35.
- 2.54 **Radio Antennae.** See Antennae. Section 2.07.
- 2.55 **Rooftop Equipment.** Approval is required.
- 2.56 **Roofing Materials.** All buildings constructed on a lot should be roofed with the same or greater quality than originally used by the Declarant or the builder. All materials require prior approval. Notwithstanding, repairs to an existing roof using the same building material that exist on the home do not require prior approval, however, attention should be paid to avoid color fading discrepancies.
- 2.57 **Satellite Dishes.** See Antennae Section 2.07.
- 2.58 **Saunas.** See Sheds Section 2.02.

2.59 **Screen Doors. See Doors Section 2.21.**

2.60 **Seasonal Decorations.** Approval is not required, provided, the decorations are not installed more than thirty (30) days before the holiday and removed within thirty (30) days after the holiday. The installation of seasonal decorations on any property owned and/or managed by the District must first have written consent of the District.

2.61 **Sewage Disposal Systems.** Are not permitted.

2.62 **Sheds.** Approval is required. Sheds shall not exceed a maximum size of 6 feet x 6 feet and 7 feet in height, and must be set back from all property lines a **minimum** of 8 feet. Sheds on the side of homes may be permitted if there is a minimum of 5 feet from the side property line to the shed and must be a lean-to style shed that is against the home.

Sheds must be constructed of wood siding. The roofing and siding colors and materials must match the existing home. Additionally, the roof overhangs must match the home (12-inches is typical), as well as a minimum 6-inch fascia width. The pitch of the shed roof must match the home. No more than one shed will per lot will be permitted.

2.63 **Exterior Shutters.** Shutters should be of a similar material and of a color and design generally accepted as complementary to the exterior of the house. Shutters must be painted using the trim or accent color of the home.

2.64 **Signs.** Approval is not required if the following conditions are met:

- A. One (1) temporary "For Sale", "Open House", "Available", "For Rent", or "For Lease" sign placed in the front yard of the lot. The sign must be professionally lettered and shall be limited to six (6) square feet and, if free standing, is mounted on a single or frame post. The overall height of the sign from the finished grade of the lot at the spot where the sign is located may not exceed four (4) feet. The sign shall be removed within two (2) business days following the sale or lease of the lot.
- B. Political signs (defined as signs that carry a message to influence the outcome of an election, including supporting or opposing the election of a candidate, the recall of a public official, or the passage of a ballot issue) are limited to one (1) sign per candidate or ballot measure, are limited to thirty-six inches (36") by forty-eight inches (48") and may only be ground mounted. The sign shall not be installed more than forty-five (45) days prior to the date of the election and shall be removed within seven (7) days after the date of the election to which the sign relates.
- C. One (1) "No Soliciting" and "Security Warning" sign near or on the front door of the residence, provided, that the sign may not exceed twenty-five (25) square inches.

Additionally, no lighted sign will be permitted unless utilized by the Declarant and/or a builder. No signs may be placed on any property owned or maintained by the District, including being attached to fencing that backs to open or public space, without the written consent of the District.

2.65 **Skylights.** Bubble style skylights are prohibited.

- 2.66 **Solar Energy Devices.** Approval is required. The owner must provide a drawing showing location of the device on the house including dimensions and color.
- A. The solar energy device is located on the roof of the residence located on the owner's lot, entirely within a fenced area of the owner's lot, or entirely within a fenced patio located on the owner's lot.
 - B. If the solar energy device is located in the fenced area of the owner's lot or patio, no portion of the solar energy device may extend above the fence line.
 - C. If the solar energy device is mounted on the roof of the principal residence located on the owner's lot, then:
 - 1. The solar energy device may not extend higher than or beyond the roofline;
 - 2. The solar energy device must conform to the slope of the roof and the top edge of the device must be parallel to the roofline;
 - 3. The frame, support brackets, visible piping or wiring associated with the solar energy device must be silver, bronze or black.
- 2.67 **Spas. See Hot Tubs and Jacuzzis Section 2.35.**
- 2.68 **Sprinkler Systems. See Irrigation Systems Section 2.36 and Irrigation Section 4.9.**
- 2.69 **Statues or Fountains. See Birdbaths, Fountains and Yard Art Section 2.12.**
- 2.70 **Storage Sheds. See Sheds Section 2.62**
- 2.71 **Sunshades. See Overhangs/Awnings Cloth or Canvas, Section. 2.41 and Patio Covers Section. 2.45.**
- 2.72 **Swamp Coolers. See Air Conditioning Equipment Section 2.06, Evaporative Coolers Section 2.24, and Rooftop Equipment Section 2.55.**
- 2.73 **Swing Sets. See Play and Sports Equipment Section 2.50.**
- 2.74 **Television Antennae. See Antennae, Section 2.07.**
- 2.75 **Temporary Structures.** No structure of a temporary character, including but not limited to, a house trailer, tent, shack, storage shed, or outbuilding shall be placed or erected upon any lot. However, during the actual construction, alteration, repair or remodeling of a structure or other Improvements, necessary temporary structures for storage of materials may be erected and maintained by the Declarant or a person doing such work. The work of constructing, altering, or remodeling any structure or other Improvements shall be prosecuted diligently from the commencement thereof until the completion thereof. **See Sheds Section 2.62.**
- 2.76 **Trash Containers, Enclosures and Pickup.** Approval is required for any trash or garbage enclosure. Refuse, garbage, trash, lumber, grass, shrub or tree clippings, plant waste,

compost, metal, bulk materials, scrap, refuse or debris of any kind may not be kept, stored or allowed to accumulate on any lot except in within the residence or in approved enclosures. No garbage or trash cans or receptacles shall be maintained in an exposed or unsightly manner (except that a container for such materials may be placed outside at such times as may be necessary to permit garbage or trash pickup.) Trash may be placed on the street for pickup after 5:00 a.m. on the day that such trash is to be picked up. Trash containers must be properly stored the evening of pickup. **See Compost Section 2.17.**

- 2.77 **Tree Houses.** Are not permitted.
- 2.78 **Utility Equipment.** Installation of utilities or utility equipment requires approval. Under the Protective Covenants, pipes, wires, poles, utility facilities must be kept and maintained, to the extent reasonably possible, underground or within an enclosed structure.
- 2.79 **Vanes. See Weathervanes and Directional Section 2.85.**
- 2.80 **Vents. See Rooftop Equipment Section 2.55 and Air Conditioning Equipment Section 2.06.**
- 2.81 **Walls. See fences Section 2.26.**
- 2.82 **Walls-Retaining. See Retaining Walls Section 4.05.**
- 2.83 **Weathervanes and Directionals.** Are not permitted.
- 2.84 **Wood Storage.** Is not permitted.

III. PROCEDURES FOR COMMITTEE APPROVAL

- 3.1 **General.** All exterior Improvements to the house and lot require written approval in advance before work on the Improvement begins. This section of the Guidelines explains how such approval can be obtained.
- 3.2 **Drawings or Plans.** Homeowners are required to submit complete plans and specifications prior to commencement of any work on any Improvement (said plans and specifications to show exterior design, height, materials, color, location of the structure or addition to the structure, plotted horizontally and vertically, location and size of driveways, general plan of landscaping, fencing, walls, windbreaks and grading plan, as well as such other materials and information as may be required). In most cases, the materials to be submitted will not have to be professionally prepared by an architect, a landscape architect or draftsman and a simple drawing and description will be sufficient. In the case of major Improvements, such as room additions, structural changes, or accessory building construction, detailed plans and specifications, prepared by a licensed architect, may be required. Whether done by you or professionally, the following guidelines should be followed in preparing drawings or plans.
- A. In some instances, elevation drawings of the proposed improvement will be required. The elevation drawings should indicate materials. The drawing or plan should be done to scale and should depict the property lines of your lot, all recorded easements and the outside boundary lines of the home as located on the lot. If you have a copy of an Improvement location certificate (survey) of your lot obtained when you purchased it, this survey would be an excellent base from which to draw.
 - B. Existing Improvements, in addition to your home, should be shown on the drawing or plan and identified or labeled. Such existing Improvements include driveways, fencing, walks, decks, trees, bushes, etc.
 - C. The proposed Improvements should be shown on the plan and labeled. Either on the plan or on an attachment, there should be a brief description of the proposed Improvement, including the materials to be used and the colors. (Example: Redwood deck, 10 feet by 12 feet with 2-inch by 4-inch decking. Natural stain.)
 - D. The plan or drawing and other materials should show the name of the homeowner, the address of the home and a telephone number where the homeowner can be reached.
- 3.3 **Submittal Requirements.** Once a plan has been developed, a plan shall be submitted to the Architectural Review Committee. The plan must contain the following information:
- A. Owner's name, address, email address, and telephone number
 - B. Designer's name, address, and telephone number (if applicable)
 - C. Scale of 1 inch = 10 feet and north arrow
 - D. All existing conditions including house, walks, driveways, patios, decks, walls, plants, trees, drainage ways, property lines, and any easements.
 - E. All proposed landscape planting improvements and landscape features such as walls, patios, structures, hot tubs, gazebos, water features, shrubs, trees, perennial and annual beds.
- 3.4 **Review Fee.** The Declaration authorizes the Architectural Review Committee to collect a fee for review the plans of proposed Improvements. Presently there is no charge for review. The

District reserves the right to charge a fee to cover the cost of any engineering consulting or other fees reasonably incurred by the District in reviewing any proposed Improvement.

- 3.5 **Action by the Architectural Review Committee.** The Architectural Review Committee will regularly review all plans submitted for approval. The Architectural Review Committee may require submission of additional material and may postpone action until all required materials have been submitted.
- 3.6 **Prosecution of Work.** A proposed Improvement to property should be accomplished as promptly and diligently as possible in accordance with the approved plans and description. The work must be completed, in any event, within one year from the date of approval. The Architectural Control Committee and District reserve the right to inspect the work and the right to file a notice of noncompliance where warranted.
- 3.7 **Rights of Appeal.** A homeowner may appeal to the Architectural Control Committee and Board of Directors of the District in the event of adverse decision, as more fully provided in the Declaration.
- 3.8 **Questions.** If you have any questions about the foregoing procedures, feel free to call the Managing Agent or Architectural Control Committee at the phone number and address listed on the request form.

IV. LANDSCAPING SUGGESTIONS

- 4.1 **General.** The purpose of this section of the Guidelines is to help you prepare an appropriate landscaping plan for your lot. Careful landscape planning and design of your site will greatly enhance the ultimate appearance of the community. The information set forth in this section is suggestive only and not mandatory. Owners are also responsible for compliance with all requirements of the District's Irrigation Water Rules and Regulations.
- 4.2 **Slopes.** In some cases, there may be relatively steep slopes on an owner's property. It is important to note that if slopes are not landscaped severe erosion and silting may occur. Therefore, it is recommended that the homeowner landscape slopes as soon as possible after moving in, if not already completed. Slopes and banks should be planted with drought tolerant plants. Terracing, or surfacing with stone or other free draining materials can lessen erosion of slopes. Loose aggregate or wood chips are not recommended on slopes unless measures are taken to prevent erosion or displacement by wind and/or water. Slopes can also be seeded with ground covers, shrubs, and bushes to prevent erosion. Rock gardens are another technique to help prevent slope erosion and create a landscape amenity. Slopes given proper design treatment can become an attractive, interesting part of the landscape.
- 4.3 **Soils/Drainage/Grading.** Your home may be constructed on "expansive soils". Prime characteristic of expansive soils is that they swell when water is introduced. The soil, in essence, acts as a sponge. When this expansion takes place, extreme pressures are exerted on foundations and other man-made structures, which are placed in the ground. The result can be severe structural damage to your home. A potential hazard exists when proper drainage is not maintained and/or when water is introduced to these "expansive soils" adjacent to your foundation.

Owners should investigate the existing drainage conditions and preserve and accommodate the drainage situation, which exists on their particular site at the time they purchased their home from the builder or other previous homeowner. **See Section 2.22 Drainage.** Grading can be used to create berm, slopes and swales which can define space, screen undesirable views, noise and high winds. It is suggested that berm slopes not exceed 3 feet of horizontal distance to 1 foot of rise or vertical height (3 to 1 slopes) in order to permit greater ease of mowing and general maintenance.

- 4.4 **Soil Preparation.** Soil conditions may vary throughout the project. Individual soil testing is suggested for each lot to determine the exact nature of the soil and the desired level of amendment needed such as mulch, sand and fertilizer to optimize plant growth. Local nurseries may offer assistance in determining the proper quantity and type of soil amendment. A general guide for amendment of all turf area soils is a minimum of three (3) cubic yards per one thousand (1,000) square feet, and ten (10) pounds per one thousand (1,000) square feet of lawn area. These materials are to be tilled to a depth of six (6) to eight (8) inches into the soil. Acceptable organic matters include aged compost, wood humus from soft/non- toxic trees, sphagnum moss (excluding that from Colorado origin), or aged/treated manures. Topsoil is not considered an acceptable organic matter.

- 4.5 **Retaining Walls.** New or old creosote treated timber railroad ties are prohibited. Rock, brick or interlocking modular units, that complement the color of the house, are preferred materials for the walls. Retaining walls may be used to accommodate or create abrupt changes in grade. Such walls should be properly anchored to withstand overturning forces. Stonewalls should be made thicker at the bottom than at the top to achieve stability. To avoid destructive freeze- thaw action, all retaining walls should incorporate weep holes into the wall design to permit water trapped behind them to be released. Walls should **not** be located so as to alter the existing drainage patterns and should provide for adequate drainage over or through (by means of weep holes) the wall structure.
- 4.6 **Climate.** Typical climatic conditions of this area include low precipitation, low average humidity, variable winds, and a fairly wide temperature range.
- 4.7 **Screening Views and Directing Winds.** Plant materials can frame pleasant vistas such as views of the mountains. Less desirable views of adjacent land (e.g. highways) can be screened with dense coniferous plantings, earth mounds, fences or walls. High velocity winds can be effectively directed by dense planting. ***Care should be taken, however, to respect and preserve views of adjacent lots.***
- 4.8 **Rockscapes.** Boulders and cobbles present an attractive alternative landscape element if used sensitively within the overall landscape composition. Large expanses of rock mulch without substantial shrub or groundcover plantings are unacceptable. Stone or gravel mulch with harsh, unnatural or high contrast colors shall be prohibited, including the use of black granite, white marble and lava rock. Boulders, cobbles, river rock, etc. is not acceptable as the only landscaping in a front or back yard. Please see **4.15 Xeriscaping** for more information.
- 4.9 **Irrigation.** The semi-arid climate makes watering necessary. It is recommended that watering be done in the early morning or evening. One of the most common tendencies is to over-saturate your lot. Homeowners are urged to conserve water and as a result minimize problems on their own lots as well as on adjacent property owner's lots caused by over-watering.

Several systems can be used to water your lawn: automatic sprinkler systems and portable sprinklers. The following are some facts to consider in selecting the type and location of the sprinkler system you are going to use:

- A. Size and shape of areas to be watered
- B. Type of turf or ground cover
- C. Available water supplies and pressure
- D. Environment of the area-wind, rain, temperature, exposure, and grades
- E. Low spraying irrigation devices may help to minimize wasted water due to wind
- F. Installation of an irrigation system directly adjacent to front sidewalks may eventually cause undermining and deterioration to concrete and paved areas
- G. Type of soil and its ability to accept water. Local nurseries or do-it-yourself sprinkler stores have detailed information concerning the type and installation of irrigation systems

- H. Drip irrigation systems are recommended for tree and shrub areas.
- 4.10 **Paved Areas.** Paving may be used to define areas of intense activity and circulation patterns, such as patios, walks, and steps. Materials that can be used to create attractive patterns and textures are brick, flagstones, steppingstones, pre- cast patterned or exposed aggregate concrete paver. These materials are often more desirable than asphalt or poured concrete. It is suggested that paving materials be earth tones colors. Sufficient slope should be maintained in all paved areas to insure proper drainage. Asphalt is not permitted.
- 4.11 **Shade.** Shade trees should be placed relatively close to the house where they can shade walls or outdoor activity areas. Avoid shading a solar collector or inhibiting the effectiveness of passive solar design measures. For example, broad- leaved deciduous trees screen out the intense summer sun but allow winter warmth to penetrate. Trees and shrubs in general should not be planted within existing drainage swales so as to block designated drainage patterns.
- 4.12 **Landscape Materials.** Deciduous trees, such as cottonwood, and evergreen trees, such as pinion pines, provide summer shade or can be used as a windbreak. Evergreens provide good backdrops for displaying ornamental trees and contrasting flowers as well as providing a visual screen.
- A. Shrubs such as junipers may be used as specimens or in masses. Shrubs can also be used in combination with trees as windbreaks or to add color and texture to the landscape. Low growing, spreading shrubs may be used as groundcover treatment and present an attractive method of reducing water consumption.
 - B. Ornamental trees such as flowering crabapples provide accent, color, and additional interest to the residential landscape and may be a more appropriate scale for small areas of a lot.
 - C. Groundcovers such as creeping mahonia play an important role in consolidating the surface of fine-grained soils to prevent erosion and sedimentation. They may be useful in place of a lawn, especially on steep banks where they will also require less water than turf grass.
 - D. Vines may be used as a groundcover or as a shading element over a trellis or as a screen when planted adjacent to a fence.
 - E. Garden flowers may be used as elements of seasonal color. Perennials and annuals should be considered.
 - F. Vegetable gardens may be integrated with planting beds and used ornamentally.
- 4.13 **Mulches.** Mulches modify the extremes of soil temperature and improve soil by producing humus and reducing evaporation loss. Suggested minimum depth for mulches is three inches. Mulches are typically used in shrubs and groundcover beds and may consist of a variety of organic materials such as ground bark, woodchips, pole peelings or chipper chips. Natural wood mulch has environmental advantages to plant material and its use is strongly encouraged. Stone or gravel mulch with harsh, unnatural or high contrast colors shall be prohibited, including the use of black granite, white marble and lava rock.
- 4.14 **Landscape Maintenance.** Good consistent maintenance is essential for healthy plant materials. The following are some suggested maintenance considerations and ways of

minimizing maintenance problems:

- A. Plant with regards to climate. Consider ultimate size, shape, and growth rate of species
- B. Locate plants and irrigation heads out of the way of pedestrian-bicycle traffic and car bumpers
- C. Provide simple guying systems for trees for a minimum of two years and wrap trees most susceptible to sun scald with burlap or paper during fall or winter months
- D. Make provisions for efficient irrigation; drain and service sprinkler systems on regular basis and conduct operational checks on a weekly basis to ensure proper performance of the system
- E. Provide good soil mixes with sufficient organic material, 30% per tilled depth is desirable.
- F. Use mulch at least three inches deep to hold soil moisture and to help prevent weeds and soil compaction
- G. Provide required fertilization, weed and pest controls etc., as required for optimum plant growth
- H. Prune woody plants when needed. Never prune more than 1/3 of foliage
- I. Space groves of trees or single trees to allow for efficient mowing
- J. Locate plants with similar water, sun and space requirements together.

4.15 **Xeriscaping** Approval is required as is living plant material.

Xeriscape landscaping involves the use low water, drought tolerant plant material. Rocks, mulch, pavers, etc. may be used to accentuate landscaping but cannot be the only materials used. Artificial turf is not permitted for front yard landscaping; however, residents may submit to install in backyards.